

SYSMAC
C200H-AD003/DA003/DA004/MAD01
Analog I/O Units

OPERATION MANUAL

OMRON

C200H-AD003/DA003/DA004/MAD01 Analog I/O Units

Operation Manual

Revised June 2003

Notice:

OMRON products are manufactured for use according to proper procedures by a qualified operator and only for the purposes described in this manual.

The following conventions are used to indicate and classify precautions in this manual. Always heed the information provided with them. Failure to heed precautions can result in injury to people or damage to property.

 **DANGER** Indicates an imminently hazardous situation which, if not avoided, will result in death or serious injury.

 **WARNING** Indicates a potentially hazardous situation which, if not avoided, could result in death or serious injury.

 **Caution** Indicates a potentially hazardous situation which, if not avoided, may result in minor or moderate injury, or property damage.

OMRON Product References

All OMRON products are capitalized in this manual. The word “Unit” is also capitalized when it refers to an OMRON product, regardless of whether or not it appears in the proper name of the product.

The abbreviation “Ch,” which appears in some displays and on some OMRON products, often means “word” and is abbreviated “Wd” in documentation in this sense.

The abbreviation “PLC” means Programmable Controller. “PC” is used, however, in some Programming Device displays to mean Programmable Controller.

Visual Aids

The following headings appear in the left column of the manual to help you locate different types of information.

Note Indicates information of particular interest for efficient and convenient operation of the product.

1,2,3... 1. Indicates lists of one sort or another, such as procedures, checklists, etc.

© OMRON Electronics LLC 1997-2003

All rights reserved. No part of this publication may be reproduced, stored in a retrieval system, or transmitted, in any form, or by any means, mechanical, electronic, photocopying, recording, or otherwise, without the prior written permission of OMRON.

No patent liability is assumed with respect to the use of the information contained herein. Moreover, because OMRON is constantly striving to improve its high-quality products, the information contained in this manual is subject to change without notice. Every precaution has been taken in the preparation of this manual. Nevertheless, OMRON assumes no responsibility for errors or omissions. Neither is any liability assumed for damages resulting from the use of the information contained in this publication.

TABLE OF CONTENTS

PRECAUTIONS	xi
1 Intended Audience	xii
2 General Precautions	xii
3 Safety Precautions	xii
4 Operating Environment Precautions	xiii
5 Application Precautions	xiii
SECTION 1	
System Design	1
1-1 Features and Functions	2
1-2 Basic Configuration	4
1-3 Setting the Unit Number	7
1-4 Operating Procedure	8
SECTION 2	
C200H-AD003 Analog Input Unit	9
2-1 Specifications	10
2-2 Nomenclature and Functions	12
2-3 Wiring	14
2-4 IR and DM Areas	17
2-5 Using the Functions	21
2-6 Offset and Gain Adjustment	27
2-7 Error Processing	33
SECTION 3	
C200H-DA003 and C200H-DA004 Analog Output Units	37
3-1 Specifications	38
3-2 Nomenclature and Functions	40
3-3 Wiring	42
3-4 IR and DM Areas	46
3-5 Using the Functions	50
3-6 Offset and Gain Adjustment	54
3-7 Error Processing	62
SECTION 4	
C200H-MAD01 Analog I/O Unit	65
4-1 Specifications	66
4-2 Nomenclature and Functions	70
4-3 Wiring	72
4-4 IR and DM Areas	76
4-5 Analog Input Functions	81
4-6 Analog Output Functions	86
4-7 Ratio Conversion Function	89
4-8 Offset and Gain Adjustment	92
4-9 Error Processing	105
Appendices	
A Dimensions	111
B Changes From Earlier Models	113
C Sample Programs	115
D Data Memory Coding Sheet	124
Index	131
Revision History	135

About this Manual:

This manual describes the installation and operation of the C200H-AD003 Analog Input Unit, the C200H-DA003/DA004 Analog Output Unit, and the C200H-MAD01 Analog I/O Unit and includes the sections described below.

The C200H-AD003 Analog Input Unit converts analog sensor output to digital format and transmits it to C200H, C200HS and C200HX/HG/HE PCs.

The C200H-DA003 and C200H-DA004 Analog Output Units convert C200H, C200HS, and C200HX/HG/HE digital data to analog format for output.

The C200H-MAD01 Analog I/O Unit provides both input and output functions.

Please read this manual carefully and be sure you understand the information provided before attempting to install and operate the C200H-AD003, C200H-DA003, C200H-DA004, or C200H-MAD01.

Section 1 describes the features and system configuration of the C200H-AD003 Analog Input Unit, the C200H-DA003 and C200H-DA004 Analog Output Units, and the C200H-MAD01 Analog I/O Unit, and explains the operations that they have in common.

Section 2 provides the information required to install and operate a C200H-AD003 Analog Input Unit.

Section 3 provides the information required to install and operate a C200H-DA003 or C200H-DA004 Analog Output Unit.

Section 4 provides the information required to install and operate a C200H-MAD01 Analog I/O Unit.

The **Appendices** provide dimensions, model change differences, sample programs, and data memory coding sheets.



WARNING Failure to read and understand the information provided in this manual may result in personal injury or death, damage to the product, or product failure. Please read each section in its entirety and be sure you understand the information provided in the section and related sections before attempting any of the procedures or operations given.

PRECAUTIONS

This section provides general precautions for using the Programmable Controller (PC) and Analog I/O Units.

The information contained in this section is important for the safe and reliable application of the Analog I/O Unit. You must read this section and understand the information contained before attempting to set up or operate a PC system and Analog I/O Unit.

1 Intended Audience	xii
2 General Precautions	xii
3 Safety Precautions	xii
4 Operating Environment Precautions	xiii
5 Application Precautions	xiii

1 Intended Audience

This manual is intended for the following personnel, who must also have knowledge of electrical systems (an electrical engineer or the equivalent).

- Personnel in charge of installing FA systems.
- Personnel in charge of designing FA systems.
- Personnel in charge of managing FA systems and facilities.

2 General Precautions

The user must operate the product according to the performance specifications described in the operation manuals.

Please use particular care before using the product under conditions which are not described in the manual or applying the product to nuclear control systems, railroad systems, aviation systems, vehicles, combustion systems, medical equipment, amusement machines, safety equipment, and other systems, machines, and equipment that may have a serious influence on lives and property if used improperly.

Make sure that the ratings and performance characteristics of the product are sufficient for the systems, machines, and equipment, and be sure to provide the systems, machines, and equipment with double safety mechanisms.

This manual provides information for using the Position Control Unit. Be sure to read this manual before attempting to use the Unit and keep this manual close at hand for reference during operation.

 **WARNING** It is extreme important that Position Control Units and related devices be used for the specified purpose and under the specified conditions, especially in applications that can directly or indirectly affect human life.

3 Safety Precautions

 **WARNING** Never attempt to disassemble any Units while power is being supplied. Doing so may result in serious electric shock.

 **WARNING** Do not attempt to disassemble, repair, or modify any Units. Any attempt to do so may result in malfunction, fire, or electric shock.

 **WARNING** Never touch any of the terminals while power is being supplied. Doing so may result in serious electric shock.

 **WARNING** Provide safety measures in external circuits (i.e., not in the Programmable Controller or Position Control Unit) to ensure safety in the system if an abnormality occurs due to malfunction of the PLC, malfunction of the PCU (Position Control Unit), or external factors affecting the operation of the PLC or PCU. Not providing sufficient safety measures may result in serious accidents.

- Emergency stop circuits, interlock circuits, limit circuits, and similar safety measures must be provided in external control circuits.
- The PLC will turn OFF all outputs when its self-diagnosis function detects any error or when a severe failure alarm (FALS) instruction is executed.

such problems, external safety measures must be provided to ensure safety in the system.

- When the 24-VDC output (service power supply to the PC) is overloaded or short-circuited, the voltage may drop and result in the outputs being turned OFF. As a countermeasure for such problems, external safety measures must be provided to ensure safety in the system.

 **Caution** Tighten the screws on the terminal block of the AC Power Supply Unit to the torque specified in the operation manual. The loose screws may result in burning or malfunction.

 **Caution** Execute online edit only after confirming that no adverse effects will be caused by extending the cycle time. Otherwise, the input signals may not be readable.

4 Operating Environment Precautions

 **Caution** Do not operate the control system in the following places:

- Locations subject to direct sunlight.
- Locations subject to temperatures or humidity outside the range specified in the specifications.
- Locations subject to condensation as the result of severe changes in temperature.
- Locations subject to corrosive or flammable gases.
- Locations subject to dust (especially iron dust) or salts.
- Locations subject to exposure to water, oil, or chemicals.
- Locations subject to shock or vibration.

 **Caution** Take appropriate and sufficient countermeasures when installing systems in the following locations:

- Locations subject to static electricity or other forms of noise.
- Locations subject to strong electromagnetic fields.
- Locations subject to possible exposure to radioactivity.
- Locations close to power supplies.

 **Caution** The operating environment of the PC System can have a large effect on the longevity and reliability of the system. Improper operating environments can lead to malfunction, failure, and other unforeseeable problems with the PC System. Be sure that the operating environment is within the specified conditions at installation and remains within the specified conditions during the life of the system.

5 Application Precautions

Observe the following precautions when using the PC.

 **WARNING** Always heed these precautions. Failure to abide by the following precautions could lead to serious or possibly fatal injury.

- Always connect to a ground of 100 Ω or less when installing the Units. Not connecting to a ground of 100 Ω or less may result in electric shock.
- Always turn off the power supply to the PC before attempting any of the following. Not turning off the power supply may result in malfunction or electric shock.

- Mounting or dismounting Power Supply Units, I/O Units, CPU Units, Memory Cassettes, or any other Units.
- Assembling the Units.
- Setting DIP switch or rotary switches.
- Connecting or wiring the cables.
- Connecting or disconnecting the connectors.

**Caution**

Failure to abide by the following precautions could lead to faulty operation of the PC or the system, or could damage the PC or PC Units. Always heed these precautions.

- Fail-safe measures must be taken by the customer to ensure safety in the event of incorrect, missing, or abnormal signals caused by broken signal lines, momentary power interruptions, or other causes.
- Interlock circuits, limit circuits, and similar safety measures in external circuits (i.e., not in the Programmable Controller) must be provided by the customer.
- Always use the power supply voltage specified in this manual. An incorrect voltage may result in malfunction or burning.
- Take appropriate measures to ensure that the specified power with the rated voltage and frequency is supplied. Be particularly careful in places where the power supply is unstable. An incorrect power supply may result in malfunction.
- Install external breakers and take other safety measures against short-circuiting in external wiring. Insufficient safety measures against short-circuiting may result in burning.
- Do not apply voltages to the Input Units in excess of the rated input voltage. Excess voltages may result in burning.
- Do not apply voltages or connect loads to the Output Units in excess of the maximum switching capacity. Excess voltage or loads may result in burning.
- Disconnect the functional ground terminal when performing withstand voltage tests. Not disconnecting the functional ground terminal may result in burning.
- Be sure that all the mounting screws, terminal screws, and cable connector screws are tightened to the torque specified in the relevant manuals. Incorrect tightening torque may result in malfunction.
- Do not attempt to disassemble, repair, or modify any Units.
- Be sure to confirm that the DIP switch and the data memory (DM) are properly set.
- Leave the label attached to the Unit when wiring. Removing the label may result in malfunction.
- Remove the labels after the completion of wiring to ensure proper heat dissipation. Leaving the label attached may result in malfunction.
- Mount the Unit only after checking the terminal block completely.
- Be sure that the terminal blocks, Memory Units, expansion cables, and other items with locking devices are properly locked into place. Improper locking may result in malfunction.
- Check the user program for proper execution before actually running it on the Unit. Not checking the program may result in an unexpected operation.
- Use crimp terminals for wiring. Do not connect bare stranded wires directly to terminals. Connection of bare stranded wires may result in burning.
- Double-check all the wiring before turning on the power supply. Incorrect wiring may result in burning.
- Confirm that no adverse effect will occur in the system before attempting any of the following. Not doing so may result in an unexpected operation.

- Changing the operating mode of the PC.
- Force-setting/force-resetting any bit in memory.
- Changing the present value of any word or any set value in memory.
- Resume operation only after transferring to the new CPU Unit the contents of the DM Area, HR Area, and other data required for resuming operation. Not doing so may result in an unexpected operation.
- Do not pull on the cables or bend the cables beyond their natural limit. Doing either of these may break the cables.
- Do not place objects on top of the cables or other wiring lines. Doing so may break the cables.
- Before touching the Unit, be sure to first touch a grounded metallic object in order to discharge any static built-up. Not doing so may result in malfunction or damage.
- When replacing parts, be sure to confirm that the rating of a new part is correct. Not doing so may result in malfunction or burning.

Certain Terms and Conditions of Sale

- Offer; Acceptance.** These terms and conditions (these "Terms") are deemed part of all catalogs, manuals or other documents, whether electronic or in writing, relating to the sale of goods or services (collectively, the "Goods") by Omron Electronics LLC and its subsidiary companies ("Seller"). Seller hereby objects to any terms or conditions proposed in Buyer's purchase order or other documents which are inconsistent with, or in addition to, these Terms. Please contact your Omron representative to confirm any additional terms for sales from your Omron company.
- Prices.** All prices stated are current, subject to change without notice by Seller. Buyer agrees to pay the price in effect at time of shipment.
- Discounts.** Cash discounts, if any, will apply only on the net amount of invoices sent to Buyer after deducting transportation charges, taxes and duties, and will be allowed only if (i) the invoice is paid according to Seller's payment terms and (ii) Buyer has no past due amounts owing to Seller.
- Orders.** Seller will accept no order less than \$200 net billing.
- Governmental Approvals.** Buyer shall be responsible for, and shall bear all costs involved in, obtaining any government approvals required for the importation or sale of the Goods.
- Taxes.** All taxes, duties and other governmental charges (other than general real property and income taxes), including any interest or penalties thereon, imposed directly or indirectly on Seller or required to be collected directly or indirectly by Seller for the manufacture, production, sale, delivery, importation, consumption or use of the Goods sold hereunder (including customs duties and sales, excise, use, turnover and license taxes) shall be charged to and remitted by Buyer to Seller.
- Financial.** If the financial position of Buyer at any time becomes unsatisfactory to Seller, Seller reserves the right to stop shipments or require satisfactory security or payment in advance. If Buyer fails to make payment or otherwise comply with these Terms or any related agreement, Seller may (without liability and in addition to other remedies) cancel any unshipped portion of Goods sold hereunder and stop any Goods in transit until Buyer pays all amounts, including amounts payable hereunder, whether or not then due, which are owing to it by Buyer. Buyer shall in any event remain liable for all unpaid accounts.
- Cancellation; Etc.** Orders are not subject to rescheduling or cancellation unless Buyer indemnifies Seller fully against all costs or expenses arising in connection therewith.
- Force Majeure.** Seller shall not be liable for any delay or failure in delivery resulting from causes beyond its control, including earthquakes, fires, floods, strikes or other labor disputes, shortage of labor or materials, accidents to machinery, acts of sabotage, riots, delay in or lack of transportation or the requirements of any government authority.
- Shipping; Delivery.** Unless otherwise expressly agreed in writing by Seller:
 - Shipments shall be by a carrier selected by Seller;
 - Such carrier shall act as the agent of Buyer and delivery to such carrier shall constitute delivery to Buyer;
 - All sales and shipments of Goods shall be FOB shipping point (unless otherwise stated in writing by Seller), at which point title to and all risk of loss of the Goods shall pass from Seller to Buyer, provided that Seller shall retain a security interest in the Goods until the full purchase price is paid by Buyer;
 - Delivery and shipping dates are estimates only.
 - Seller will package Goods as it deems proper for protection against normal handling and extra charges apply to special conditions.
- Claims.** Any claim by Buyer against Seller for shortage or damage to the Goods occurring before delivery to the carrier must be presented in writing to Seller within 30 days of receipt of shipment and include the original transportation bill signed by the carrier noting that the carrier received the Goods from Seller in the condition claimed.
- Warranties.** (a) **Exclusive Warranty.** Seller's exclusive warranty is that the Goods will be free from defects in materials and workmanship for a period of twelve months from the date of sale by Seller (or such other period expressed in writing by Seller). Seller disclaims all other warranties, express or implied. (b) **Limitations.** SELLER MAKES NO WARRANTY OR REPRESENTATION, EXPRESS OR IMPLIED, ABOUT NON-INFRINGEMENT, MERCHANTABILITY OR FITNESS FOR A PARTICULAR PURPOSE OF THE GOODS. BUYER ACKNOWLEDGES THAT IT ALONE HAS DETERMINED THAT THE GOODS WILL SUITABLY MEET THE REQUIREMENTS OF THEIR INTENDED USE. Seller further disclaims all warranties and responsibility of any type for claims or expenses based on infringement by the Goods or otherwise of any intellectual property right. (c) **Buyer Remedy.** Seller's sole obligation hereunder shall be to replace (in the form originally shipped with Buyer responsible for labor charges for removal or replacement thereof) the non-complying Good or, at Seller's election, to repay or credit Buyer an amount equal to the purchase price of the Good; provided that in no event shall Seller be responsible for warranty, repair, indemnity or any other claims or expenses regarding the Goods unless Seller's analysis confirms that the Goods were properly handled, stored, installed and maintained and not subject to contamination, abuse, misuse or inappropriate modification. Return of any goods by Buyer must be approved in writing by Seller before shipment. Seller shall not be liable for the suitability or unsuitability or the results from the use of Goods in combination with any electrical or electronic components, circuits, system assemblies or any other materials or substances or environments. Any advice, recommendations or information given orally or in writing, are not to be construed as an amendment or addition to the above warranty.
- Damage Limits; Etc.** SELLER SHALL NOT BE LIABLE FOR SPECIAL, INDIRECT OR CONSEQUENTIAL DAMAGES, LOSS OF PROFITS OR PRODUCTION OR COMMERCIAL LOSS IN ANY WAY CONNECTED WITH THE GOODS, WHETHER SUCH CLAIM IS BASED IN CONTRACT, WARRANTY, NEGLIGENCE OR STRICT LIABILITY. Further, in no event shall liability of Seller exceed the individual price of the Good on which liability is asserted.
- Indemnities.** Buyer shall indemnify and hold harmless Seller, its affiliates and its employees from and against all liabilities, losses, claims, costs and expenses (including attorney's fees and expenses) related to any claim, investigation, litigation or proceeding (whether or not Seller is a party) which arises or is alleged to arise from Buyer's acts or omissions under these Terms or in any way with respect to the Goods. Without limiting the foregoing, Buyer (at its own expense) shall indemnify and hold harmless Seller and defend or settle any action brought against Seller to the extent that it is based on a claim that any Good made to Buyer specifications infringed intellectual property rights of another party.
- Property; Confidentiality.** The intellectual property embodied in the Goods is the exclusive property of Seller and its affiliates and Buyer shall not attempt to duplicate it in any way without the written permission of Seller. Notwithstanding any charges to Buyer for engineering or tooling, all engineering and tooling shall remain the exclusive property of Seller. All information and materials supplied by Seller to Buyer relating to the Goods are confidential and proprietary, and Buyer shall limit distribution thereof to its trusted employees and strictly prevent disclosure to any third party.
- Miscellaneous.** (a) **Waiver.** No failure or delay by Seller in exercising any right and no course of dealing between Buyer and Seller shall operate as a waiver of rights by Seller. (b) **Assignment.** Buyer may not assign its rights hereunder without Seller's written consent. (c) **Amendment.** These Terms constitute the entire agreement between Buyer and Seller relating to the Goods, and no provision may be changed or waived unless in writing signed by the parties. (d) **Severability.** If any provision hereof is rendered ineffective or invalid, such provision shall not invalidate any other provision. (e) **Setoff.** Buyer shall have no right to set off any amounts against the amount owing in respect of this invoice. (f) As used herein, "including" means "including without limitation".

Certain Precautions on Specifications and Use

- Suitability of Use.** Seller shall not be responsible for conformity with any standards, codes or regulations which apply to the combination of the Good in the Buyer's application or use of the Good. At Buyer's request, Seller will provide applicable third party certification documents identifying ratings and limitations of use which apply to the Good. This information by itself is not sufficient for a complete determination of the suitability of the Good in combination with the end product, machine, system, or other application or use. The following are some examples of applications for which particular attention must be given. This is not intended to be an exhaustive list of all possible uses of this Good, nor is it intended to imply that the uses listed may be suitable for this Good:
 - Outdoor use, uses involving potential chemical contamination or electrical interference, or conditions or uses not described in this document.
 - Energy control systems, combustion systems, railroad systems, aviation systems, medical equipment, amusement machines, vehicles, safety equipment, and installations subject to separate industry or government regulations.
 - Systems, machines and equipment that could present a risk to life or property. Please know and observe all prohibitions of use applicable to this Good.NEVER USE THE PRODUCT FOR AN APPLICATION INVOLVING SERIOUS RISK TO LIFE OR PROPERTY WITHOUT ENSURING THAT THE SYSTEM AS A WHOLE HAS BEEN DESIGNED TO ADDRESS THE RISKS, AND THAT THE SELLER'S PRODUCT IS PROPERLY RATED AND INSTALLED FOR THE INTENDED USE WITHIN THE OVERALL EQUIPMENT OR SYSTEM.
- Programmable Products.** Seller shall not be responsible for the user's programming of a programmable Good, or any consequence thereof.
- Performance Data.** Performance data given in this catalog is provided as a guide for the user in determining suitability and does not constitute a warranty. It may represent the result of Seller's test conditions, and the user must correlate it to actual application requirements. Actual performance is subject to the Seller's Warranty and Limitations of Liability.
- Change in Specifications.** Product specifications and accessories may be changed at any time based on improvements and other reasons. It is our practice to change part numbers when published ratings or features are changed, or when significant construction changes are made. However, some specifications of the Good may be changed without any notice. When in doubt, special part numbers may be assigned to fix or establish key specifications for your application. Please consult with your Seller's representative at any time to confirm actual specifications of purchased Good.
- Errors and Omissions.** The information in this catalog has been carefully checked and is believed to be accurate; however, no responsibility is assumed for clerical, typographical or proofreading errors, or omissions.

SECTION 1

System Design

This section describes the features and system configuration of the C200H-AD003 Analog Input Unit, the C200H-DA003 and C200H-DA004 Analog Output Units, and the C200H-MAD01 Analog I/O Unit, and explains the operations that they have in common.

1-1	Features and Functions	2
1-2	Basic Configuration	4
1-3	Setting the Unit Number	7
1-4	Operating Procedure	8

1-1 Features and Functions

Analog Input Unit

C200H-AD003

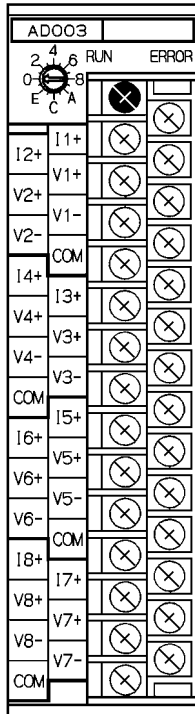

Analog Output Units

C200H-DA003

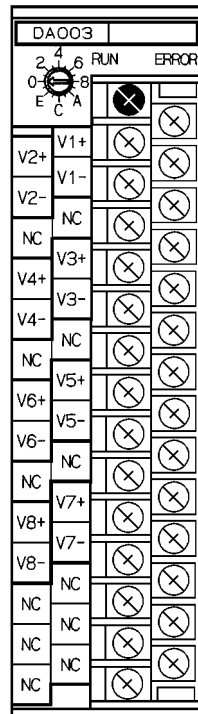

C200H-DA004

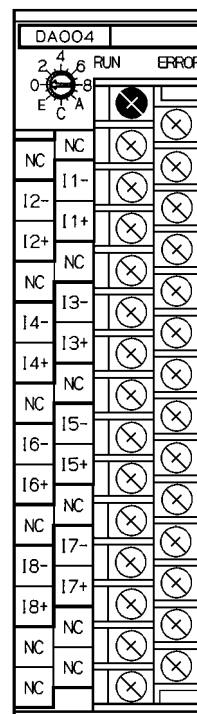

Analog I/O Unit

C200H-MAD01

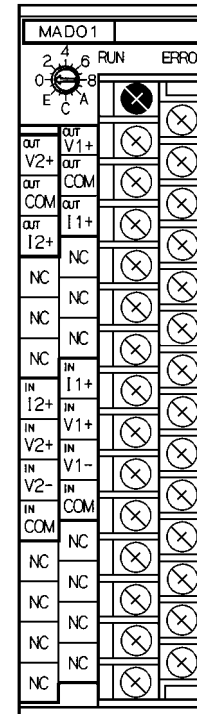

Units for C200H, C200HS, and C200HX/HG/HE PCs

These special-purpose Units enable highly accurate analog input and output at a resolution of 4,000, for C200H, C200HS, and C200HX/HG/HE PC systems. The C200H-AD003 Analog Input Unit converts analog sensor output to digital format and transmits it to C200H, C200HS and C200HX/HG/HE PCs. The C200H-DA003 and C200H-DA004 Analog Output Units convert C200H, C200HS, and C200HX/HG/HE digital data to analog format for output. The C200H-MAD01 Analog I/O Unit provides both input and output functions.

Item		C200H-AD003	C200H-DA003	C200H-DA004	C200H-MAD01
Analog input	Maximum input points	8	---	---	2
	Input signal range (See note.)	-10 to 10 V 0 to 10 V 1 to 5 V 4 to 20 mA	---	---	-10 to 10 V 0 to 10 V 1 to 5 V 4 to 20 mA
	Minimum input points	---	8	8	2
Analog output	Output signal range (See note.)	---	-10 to 10 V 0 to 10 V 1 to 5 V	4 to 20 mA	-10 to 10 V 0 to 10 V 1 to 5 V 4 to 20 mA

Note The input and output signal ranges can be set individually for each input.

High-speed Conversion

The Analog Input and Output Units provide high-speed data conversion at 1 ms per I/O point. The sampling period can be further shortened by setting unused inputs and outputs so their use is prohibited.

Input Disconnection Detection Function

The input disconnection detection function can be used for analog inputs within an input signal range of 1 to 5 V (4 to 20 mA). When this function is set for use, any input under 0.3 V will be regarded as a disconnection. For details, refer to 2-5-5 *Input Disconnection Detection Function* and 4-5-5 *Input Disconnection Detection Function*.

Peak Value Function

The peak value function holds the maximum digital conversion value for every input (including mean value processing). This function can be used with analog input. The following diagram shows how digital conversion values are affected when the peak value function is used. For details, refer to 2-5-4 *Peak Value Function*.

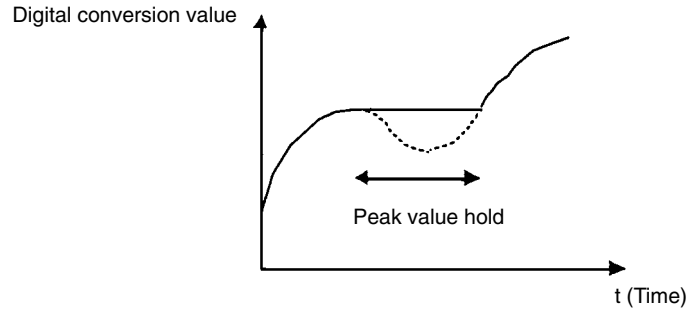

Output Hold Function

The output hold function can be used to hold the analog output value at any pre-set value when there is an error at the PC's CPU Unit. When conversion is stopped, CLR, HOLD, or MAX can be selected for output. For details, refer to 3-5-2 *Output Hold Function*.

Mean Value Function

The mean value function can be used to remove erroneous values that occur due to factors such as noise that is included in analog inputs. The operating mean is taken without affecting the data refresh cycle. For details, refer to 2-5-3 *Mean Value Processing* and 4-5-3 *Mean Value Processing*.

Offset and Gain Adjustment Function

The A/D and D/A converter offset deviation and gain deviation can be adjusted for each input and output. The offset and gain adjustments are made with the Unit set for the adjustment mode, and the adjustment values are stored in the Unit's built-in EEPROM. For details, refer to 2-6 *Offset Gain Adjustment*, 3-6 *Offset Gain Adjustment*, and 4-8 *Offset Gain Adjustment*.

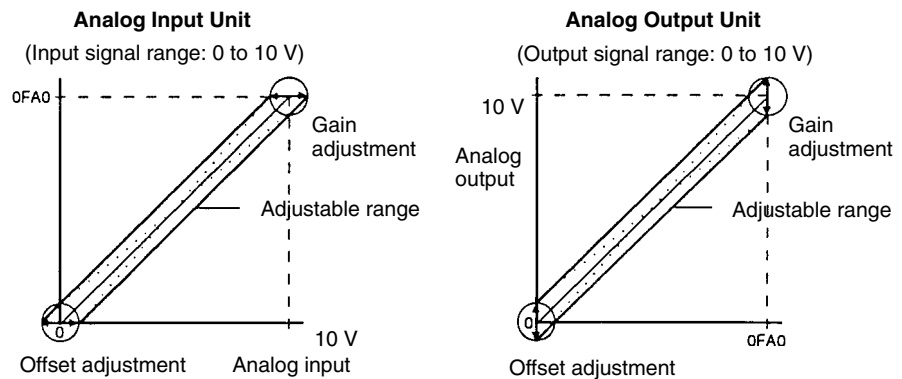

Ratio Conversion Function

The C200H-MAD01 Analog I/O Unit can output in analog format the results of analog inputs calculated for ratio and bias. For details, refer to 4-7 *Ratio Conversion Function*.

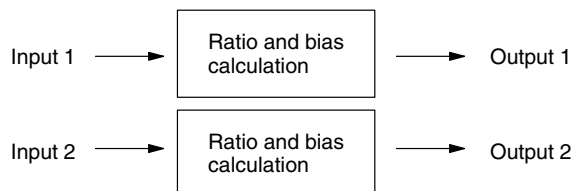

1-2 Basic Configuration

The basic system configuration is shown in the following diagram, using the C200H-AD003 Analog Input Unit and the C200H-DA003 Analog Output Unit as examples.

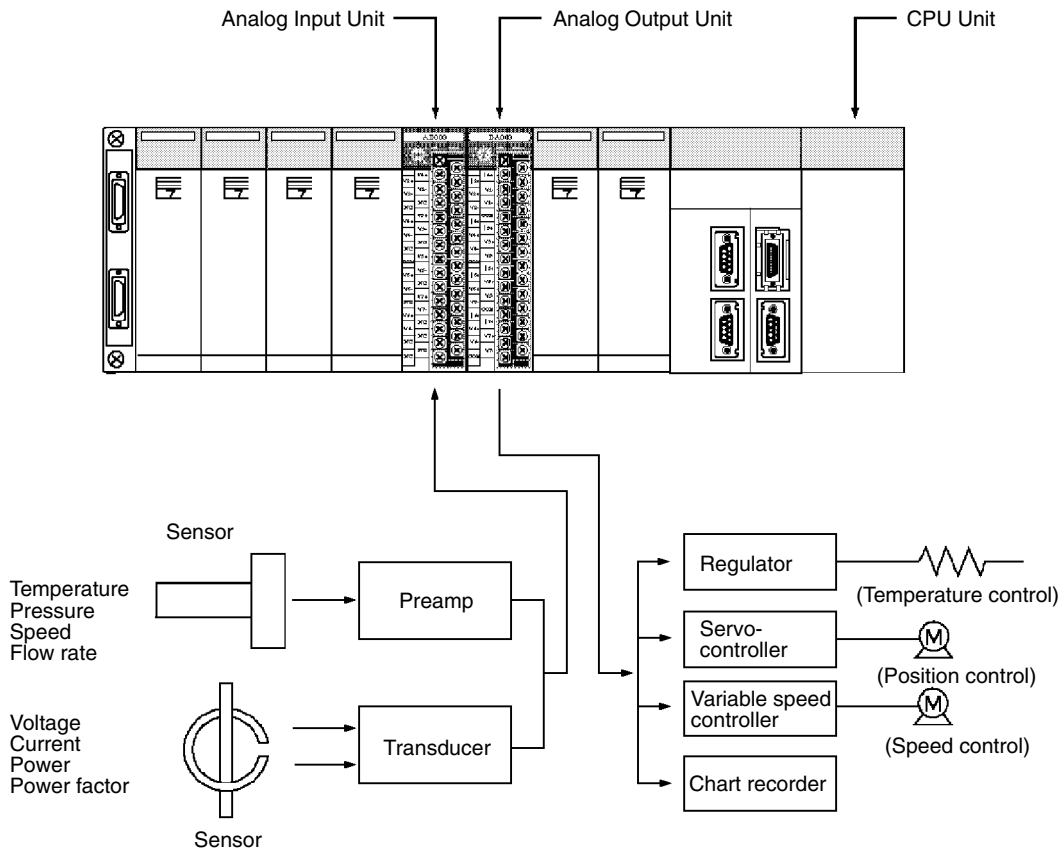

Number of Units

Analog I/O Units are classified as C200H, C200HS, and C200HX/HG/HE Special I/O Units. The maximum totals of Special I/O Units (including PC Link Units) that can be mounted to a single CPU Unit are shown in the following table.

Item	C200H, C200HS, C200HE C200HX/HG-CPU3□-E/4□-E	C200HX/HG-CPU5□-E/6□-E
Number of Units	10 max.	16 max.

The Units that belong to the various Special I/O Unit groups are shown in the following table. Their usage is limited according to the maximum current provided for the Rack and the amount of current consumed by each Unit. For details, refer to the *C200H, C200HS, or C200HX/HG/HE Installation Guide*.

There are restrictions on the number of Analog I/O Units that can be mounted on a single CPU Rack, I/O Expansion Rack, or Remote I/O Slave Rack. Ensure that the number of Units does not exceed the corresponding total given in the following table and that the total current consumption of the Analog I/O Units and the Units mounted to the same Rack does not exceed the maximum current provided for the Rack.

Limitations Due to Unit Current Consumption

Rack type	Rack model	Number of Analog I/O Units that can be mounted on the same Rack				
		AD003	DA003	DA004	MAD01	Combinations of the models on the left
C200HX/HG/HE CPU Rack or I/O Expansion Rack	C200HW-PA204	6	3	2	3	Total current consumption for all Units ≦ Supply capability of the Rack
	C200HW-PA204S					
	C200HW-PA204R					
	C200HW-PD024					
C200HS CPU Rack, I/O Expansion Rack, or Remote I/O Slave Rack	C200HS-CPU01-C	6	3	2	3	Total current consumption for all Units ≦ Supply capability of the Rack
	C200HS-CPU21-C					
	C200H-PS221-C					
	C200H-RT201-C					

There are usage limitations for Remote I/O Slave Racks. Refer to *Slave Racks* below for details.

Slave Racks

Certain limitations apply to the number of Special I/O Units that can be mounted on Slave Racks. The following table shows the maximum number of Group A, B, C, and D Special I/O Units that can be mounted on a single Slave Rack when only Units of that group are used.

Item	A	B	C	D
Type of Unit	High-speed Counters Position Control Units (NC111/112) ASCII Units Analog I/O Units ID Sensor Units Fuzzy Logic Units	High-density I/O Units Temperature Control Units PID Control Units Cam Positioner Units	Temperature Sensor Units Voice Units	Position Control Units (NC211)
Mountable number	4 Units	8 Units	6 Units	2 Units

If Units from any of the four groups are to be combined, then both of the following two equations must be satisfied.

$$3A + B + 2C + 6D \leq 12$$

$$A + B + C + D \leq 8$$

When considering the limitations on the numbers of different types of Special I/O Units that can be used, refer also to *Number of Units* previously described.

System Configuration Considerations

Special I/O Units are allocated IR area addresses according to the unit number switch settings on their front panels, and not according to the slots in which they are mounted.

With the C200H, do not mount an Analog I/O Unit in the two slots adjacent to the CPU Unit. Doing so would prevent peripheral devices such as the Programming Console from being connected.

Special I/O Units cannot be used on a C200H Remote I/O Slave Rack if the Slave Rack is connected to different PC (i.e., C500, C1000H, or C2000H).

Mounting Analog I/O Units Use the following procedure to mount an Analog I/O Unit to the Backplane.

- 1, 2, 3...
1. Lock the top of the Analog I/O Unit into the slot on the Backplane and rotate the Unit downwards as shown in the following diagram.

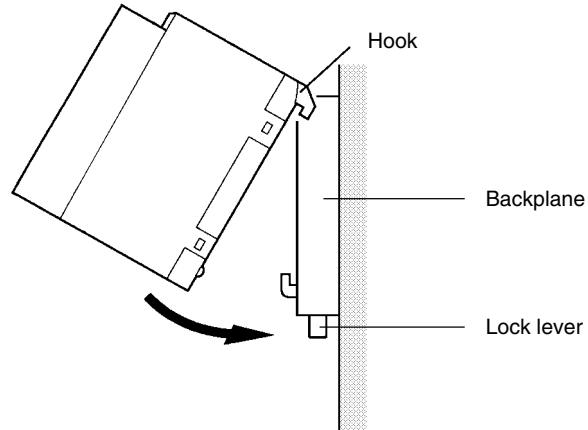

2. While making sure to align the Unit properly with the connectors, press down on the lock lever at the bottom of the slot, press the Unit firmly into position, and then release the lock lever.
(To remove a Unit, hold down the lock lever with an implement such as a screwdriver.)

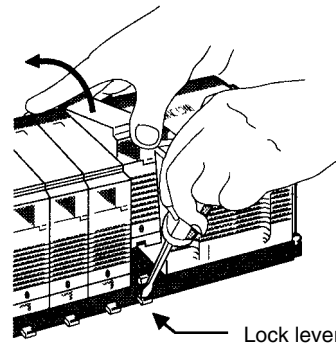

Leave enough space below each Rack, as shown in the following diagram for mounting and removing the Units.

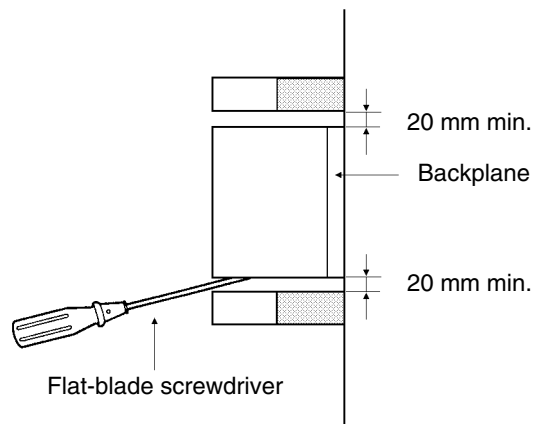

Precautions

Be sure to turn off the power supply to the PC before installing or disconnecting Units or connecting lines.
To reduce the risk of malfunctioning due to electrical noise, wire input and output lines in separate ducts from high-voltage and power lines.

When wiring a Unit, place a cover over the top of the Unit to prevent wire clippings and so on from getting inside. When the wiring has been completed, the cover must be removed to prevent heat radiation.

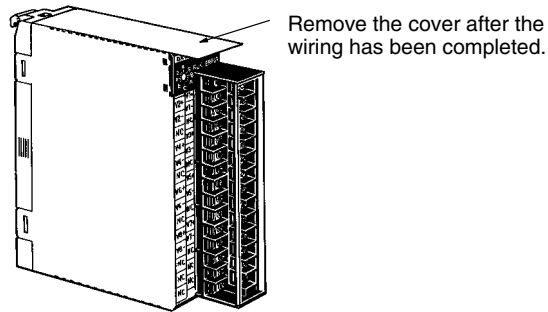

1-3 Setting the Unit Number

The CPU Unit and Analog I/O Units exchange data via the IR area and the DM area. The IR and DM word numbers that each Analog I/O Unit occupies are set by the unit number switch on the front panel of the Unit.

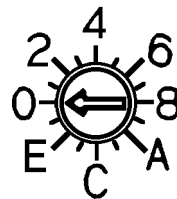

Unit number switch

Switch setting	Unit number	IR words	DM words
0	Unit #0	IR 100 to 109	DM 1000 to 1099
1	Unit #1	IR 110 to 119	DM 1100 to 1199
2	Unit #2	IR 120 to 129	DM 1200 to 1299
3	Unit #3	IR 130 to 139	DM 1300 to 1399
4	Unit #4	IR 140 to 149	DM 1400 to 1499
5	Unit #5	IR 150 to 159	DM 1500 to 1599
6	Unit #6	IR 160 to 169	DM 1600 to 1699
7	Unit #7	IR 170 to 179	DM 1700 to 1799
8	Unit #8	IR 180 to 189	DM 1800 to 1899
9	Unit #9	IR 190 to 199	DM 1900 to 1999
A	Unit #A	IR 400 to 409	DM 2000 to 2099
B	Unit #B	IR 410 to 419	DM 2100 to 2199
C	Unit #C	IR 420 to 429	DM 2200 to 2299
D	Unit #D	IR 430 to 439	DM 2300 to 2399
E	Unit #E	IR 440 to 449	DM 2400 to 2499
F	Unit #F	IR 450 to 459	DM 2500 to 2599

- Note**
- Switches A to F can be set for the C200HX/HG-CPU5□-E/6□-E. Setting numbers A to F for C200H, C200HS, C200HE, or C200HX/HG-CPU3□-E/4□-E PCs will cause an I/O UNIT OVER error and the Unit will not operate.
 - If two or more Special I/O Units are assigned the same unit number, an I/O UNIT OVER error will be generated and the PC will not operate.

1-4 Operating Procedure

Follow the procedure outlined below when using Analog I/O Units.

Installation and Settings

- 1, 2, 3...**
1. Set the DIP switch on the rear panel of the Unit to normal mode.
 2. Wire the Unit.
 3. Use the switch on the front panel of the Unit to set the unit number.
 4. Turn on the power to the PC.
 5. Make the DM area settings.
 - Set the I/O addresses to be used.
 - Set the input and output signal ranges.
 - Set the number of mean processing samplings. (AD003/MAD01 only)
 - Set the output hold function. (DA003/DA004/MAD01 only)
 - Set the ratio conversion usage, the ratio set value, and the bias value. (MAD01 only)
 6. Power up the PC again or turn the Special I/O Unit Restart Bit to ON and then OFF again.

When the input or output of the connected devices needs to be calibrated, follow the procedures in *Offset Gain Adjustment* below. Otherwise, skip to *Operation* below.

Offset Gain Adjustment

- 1, 2, 3...**
1. Set the DIP switch on the rear panel of the Unit to adjustment mode.
 2. Turn on the power to the PC.
 3. Adjust the offset and gain.
 4. Turn off the power to the PC.
 5. Change the setting of the DIP switch on the rear panel of the Unit back to normal mode.

Operation

Ladder program

- Read conversion values or write set values by means of MOV(21) and XFER(70).
- Start and stop conversion output.
- Specify the peak hold function.
- Obtain disconnection notifications and error codes.

SECTION 2

C200H-AD003 Analog Input Unit

This section provides the information required to install and operate a C200H-AD003 Analog Input Unit.

2-1	Specifications	10
2-1-1	General Specifications	10
2-1-2	Performance Specifications	10
2-1-3	Input Specifications	11
2-2	Nomenclature and Functions	12
2-2-1	Indicators	13
2-2-2	Unit Number Switch	13
2-2-3	Operation Mode Switch	14
2-3	Wiring	14
2-3-1	Terminal Arrangement	14
2-3-2	Internal Circuitry	15
2-3-3	Line Breakage while Using Voltage Input	15
2-3-4	Input Wiring Example	16
2-3-5	Input Wiring Considerations	17
2-4	IR and DM Areas	17
2-4-1	IR Area Allocation and Contents	17
2-4-2	DM Allocation and Contents	20
2-5	Using the Functions	21
2-5-1	Setting Inputs and Signal Ranges	21
2-5-2	Reading Conversion Values	22
2-5-3	Mean Value Processing	23
2-5-4	Peak Value Function	25
2-5-5	Input Disconnection Detection Function	25
2-6	Offset and Gain Adjustment	27
2-6-1	Adjustment Mode Operational Flow	27
2-6-2	Offset and Gain Adjustment Procedures	28
2-7	Error Processing	33
2-7-1	Troubleshooting Procedure	33
2-7-2	Errors Detected by Analog Input Unit	33
2-7-3	Errors Detected by CPU Unit	34
2-7-4	Restarting Special I/O Units	34
2-7-5	Troubleshooting	35

2-1 Specifications

2-1-1 General Specifications

All general specifications of the C200H-AD003 Analog Input Unit conform to those of the C200H, C200HS, and C200HX/HG/HE Series.

2-1-2 Performance Specifications

Item	C200H-AD003		
	Voltage input	Current input	
Number of analog inputs	8		
Input signal range (note 1)	0 to 10 V -10 to 10 V 1 to 5 V	4 to 20 mA	
Max. input signal (note 2)	±15 V	±30 mA	
Input impedance	1 MΩ min.	250 Ω (rated value)	
Resolution	1/4000 (full scale)		
Converted output data	16-bit binary data		
Accuracy (note 3)	23°±2°C	±0.2% of full scale	±0.4% of full scale
	0° to 55°C	±0.4% of full scale	±0.6% of full scale
Conversion time (note 4)	1.0 ms/point		
Isolation	Between input terminals and PC: photocoupler (No isolation between individual input signals.)		
External connectors	28-point terminal block (M3 screws)		
Power consumption	100 mA max. at 5 VDC 100 mA max. at 26 VDC		
Dimensions	34.5 x 130 x 128 (W x H x D) mm (refer to <i>Appendix A Dimensions</i>)		
Weight	450 g max.		

- Note**
1. The input signal range can be set individually for each input.
 2. Operation in ranges beyond the maximum input signals will damage the Unit. Operate within the ranges listed above.
 3. The accuracy is given for full scale. For example, an accuracy of ±0.2% means a maximum error of ±8 (BCD).
The default setting is adjusted with the voltage input. When using the current input, perform the offset and gain adjustment as required.
 4. A/D conversion time is the time it takes for an analog signal to be stored in memory as converted data after it has been input. It takes at least one cycle before the converted data is read by the CPU Unit.
By executing an I/O refresh, the conversion time may be extended by an additional 0.3 ms approximately.

2-1-3 Input Specifications

Range: 1 to 5 V (4 to 20 mA)

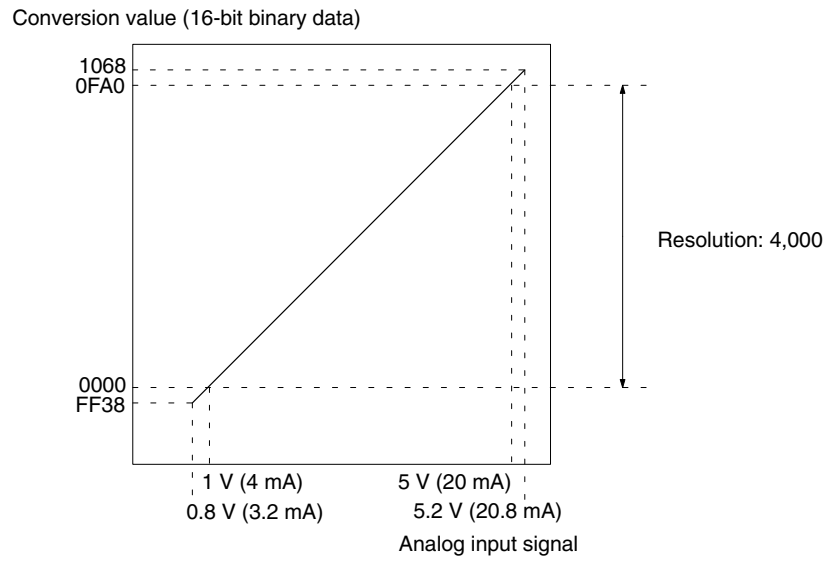

Range: 0 to 10 V

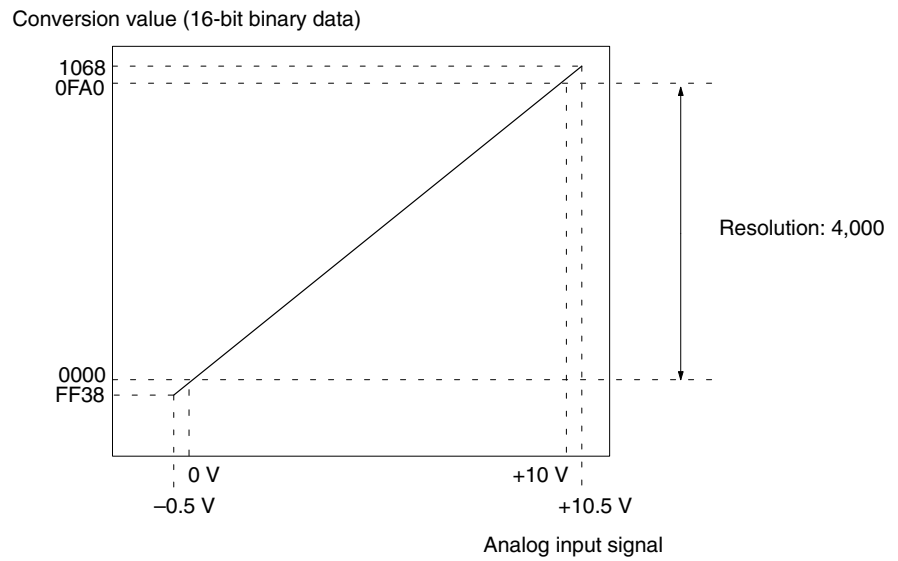

Range: -10 to 10 V

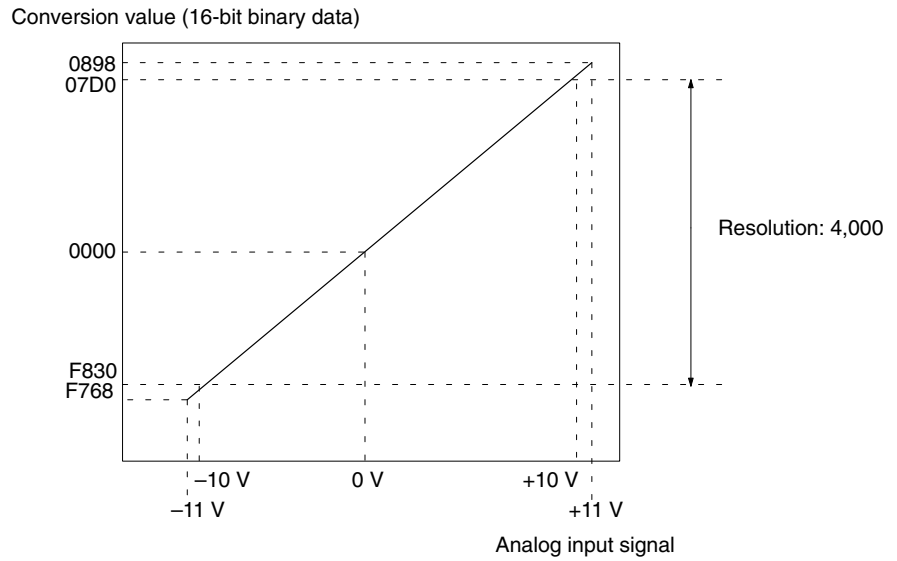

2-2 Nomenclature and Functions

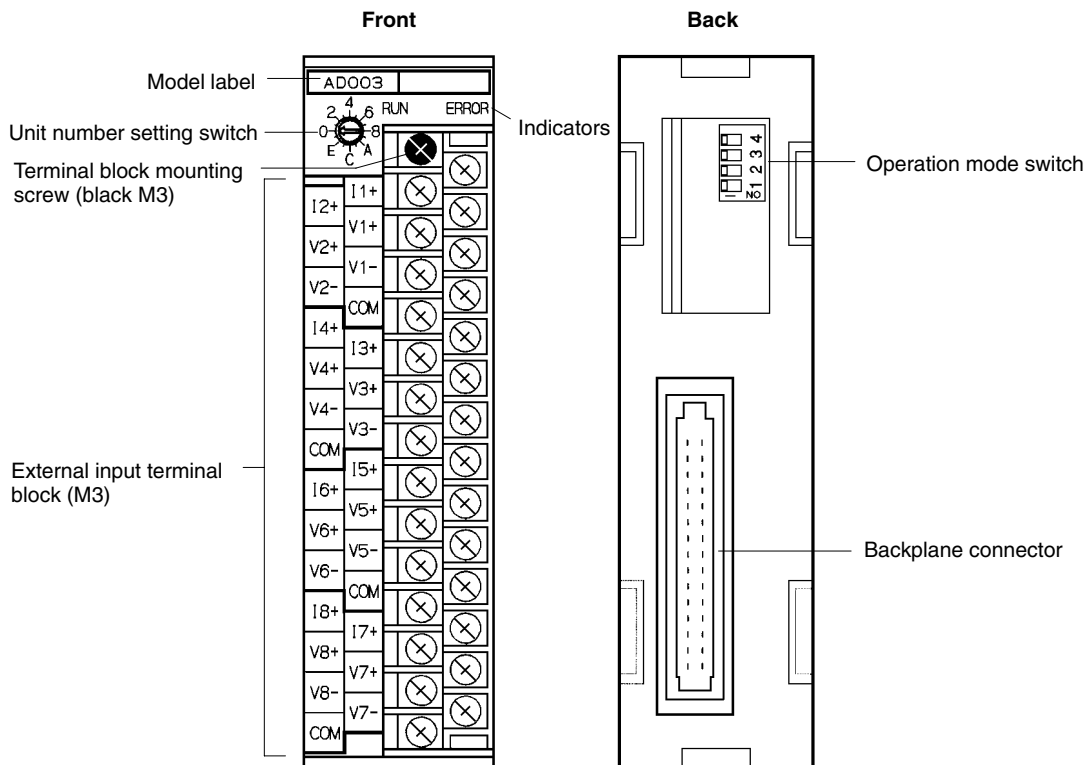

The terminal block is attached by a connector. It can be removed by loosening the black mounting screw. When removing the terminal block after wiring, remove the wire connected to the top terminal of the right column.

Check to be sure that the black terminal block mounting screw is securely tightened to a torque of 0.5 N • m.

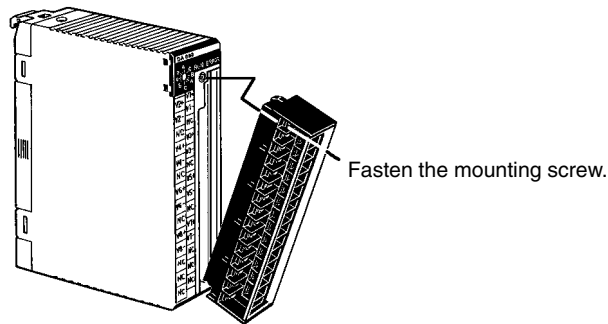

2-2-1 Indicators

The RUN and ERROR indicators show the operating status of the Unit. The following table shows the meanings of the indicators.

LED	Indicator	Operating status
RUN (green)	Lit	Operating in normal mode.
	Flashes	Operating in adjustment mode.
	Not lit	Abnormal (Unit operation stopped)
ERROR (red)	Lit	Error occurred. The error codes are stored in bits 08 to 15 of word n+9.
	Not lit	Other than the above.

2-2-2 Unit Number Switch

The CPU Unit and Analog Input Unit exchange data via the IR area and the DM area. The IR and DM word addresses that each Analog Input Unit occupies are set by the unit number switch on the front panel of the Unit.

Always turn off the power before setting the unit number. Use a flat-blade screwdriver, being careful not to damage the slot in the screw. Be sure not to leave the switch midway between settings.

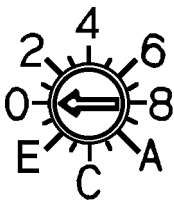

Switch setting	Unit number	IR words	DM words
0	Unit #0	IR 100 to 109	DM 1000 to 1099
1	Unit #1	IR 110 to 119	DM 1100 to 1199
2	Unit #2	IR 120 to 129	DM 1200 to 1299
3	Unit #3	IR 130 to 139	DM 1300 to 1399
4	Unit #4	IR 140 to 149	DM 1400 to 1499
5	Unit #5	IR 150 to 159	DM 1500 to 1599
6	Unit #6	IR 160 to 169	DM 1600 to 1699
7	Unit #7	IR 170 to 179	DM 1700 to 1799
8	Unit #8	IR 180 to 189	DM 1800 to 1899
9	Unit #9	IR 190 to 199	DM 1900 to 1999
A	Unit #A	IR 400 to 409	DM 2000 to 2099
B	Unit #B	IR 410 to 419	DM 2100 to 2199
C	Unit #C	IR 420 to 429	DM 2200 to 2299
D	Unit #D	IR 430 to 439	DM 2300 to 2399
E	Unit #E	IR 440 to 449	DM 2400 to 2499
F	Unit #F	IR 450 to 459	DM 2500 to 2599

- Note**
- Switches A to F can be set for the C200HX/HG-CPU5□-E/6□-E. Setting numbers A to F for C200H, C200HS, C200HE, or C200HX/HG-CPU3□-E/4□-E PCs will cause an I/O UNIT OVER error and the Unit will not operate.
 - If two or more Special I/O Units are assigned the same unit number, an I/O UNIT OVER error will be generated and the PC will not operate.

2-2-3 Operation Mode Switch

The operation mode switch on the back of the Unit is used to set the operation mode to either normal mode or adjustment mode (for adjusting offset and gain).

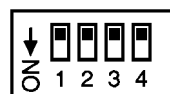

Pin number				Mode
1	2	3	4	
OFF	OFF	OFF	OFF	Normal mode
ON	OFF	OFF	OFF	Adjustment mode

Caution Do not set the pins to any combination other than those shown in the above table. Be sure to set pins 2, 3, and 4 to OFF.

Caution Be sure to turn off the power to the PC before changing the operation mode switch settings.

2-3 Wiring

2-3-1 Terminal Arrangement

The signal names corresponding to the connecting terminals are as shown in the following diagram.

Current input 2 (+)	B0	A0	Current input 1 (+)
Voltage input 2 (+)	B1	A1	Voltage input 1 (+)
Voltage input 2 (-)	B2	A2	Voltage input 1 (-)
Current input 4 (+)	B3	A3	COM (analog 0 V)
Voltage input 4 (+)	B4	A4	Current input 3 (+)
Voltage input 4 (-)	B5	A5	Voltage input 3 (+)
COM (analog 0 V)	B6	A6	Voltage input 3 (-)
Current input 6 (+)	B7	A7	Current input 5 (+)
Voltage input 6 (+)	B8	A8	Voltage input 5 (+)
Voltage input 6 (-)	B9	A9	Voltage input 5 (-)
Current input 8 (+)	B10	A10	COM (analog 0 V)
Voltage input 8 (+)	B11	A11	Current input 7 (+)
Voltage input 8 (-)	B12	A12	Voltage input 7 (+)
COM (analog 0 V)	B13	A13	Voltage input 7 (-)

- Note**
- The analog input numbers that can be used are set in the Data Memory (DM).

2. The input signal ranges for individual inputs are set in the Data Memory (DM). They can be set in units of analog input numbers.
3. The COM terminal is connected to the 0-V analog circuit in the Unit. Connecting shielded input lines can improve noise resistance.

2-3-2 Internal Circuitry

The following diagram shows the internal circuitry of the analog input section.

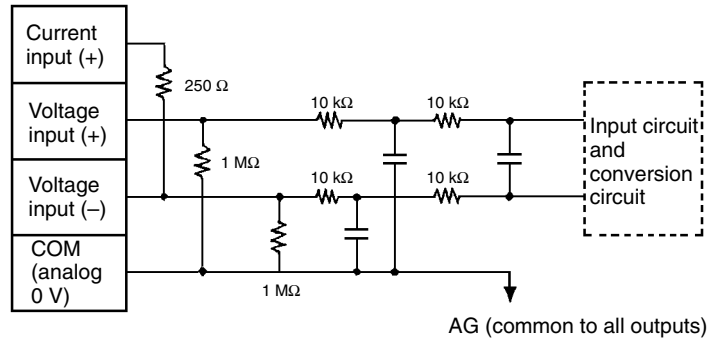

2-3-3 Line Breakage while Using Voltage Input

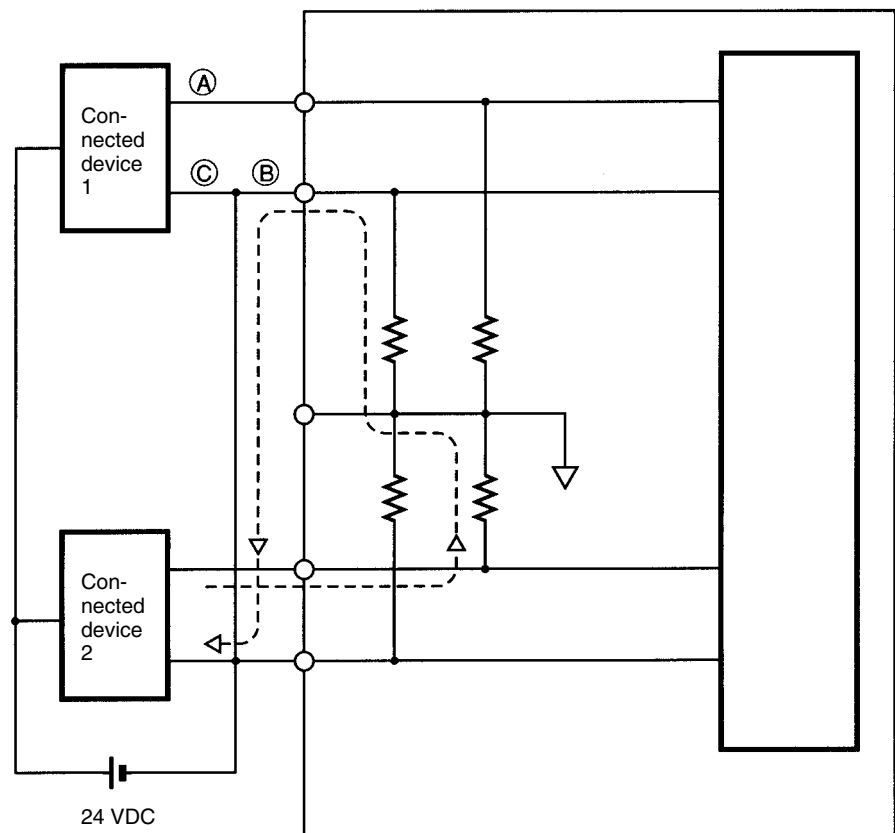

Note If the power supply is shared by two channels as shown above, while the connected device 2 outputs 5 V, approximately 1.6 V (one-third of the output voltage) is generated in input 1.

If a line breakage occurs while using the voltage input, either separate the power supply from the connected device or use an isolator for each input to avoid the following problem.

If the line breakage occurs at point A or B as shown in the preceding diagram while power is shared by the connected devices, a short-circuit line will be formed as indicated by the dotted line in the above illustration, thus generating a voltage of approximately one-third to two-thirds of the voltage output from the connected device. If this kind of voltage is generated while using the Unit at 1 to 5 V, the line breakage may not be detected. If the line breakage occurs at point C, it will not be detected because the negative (-) side is common.

In case of the current input, this kind of problem will not occur even if the power supply is shared by the connected devices.

2-3-4 Input Wiring Example

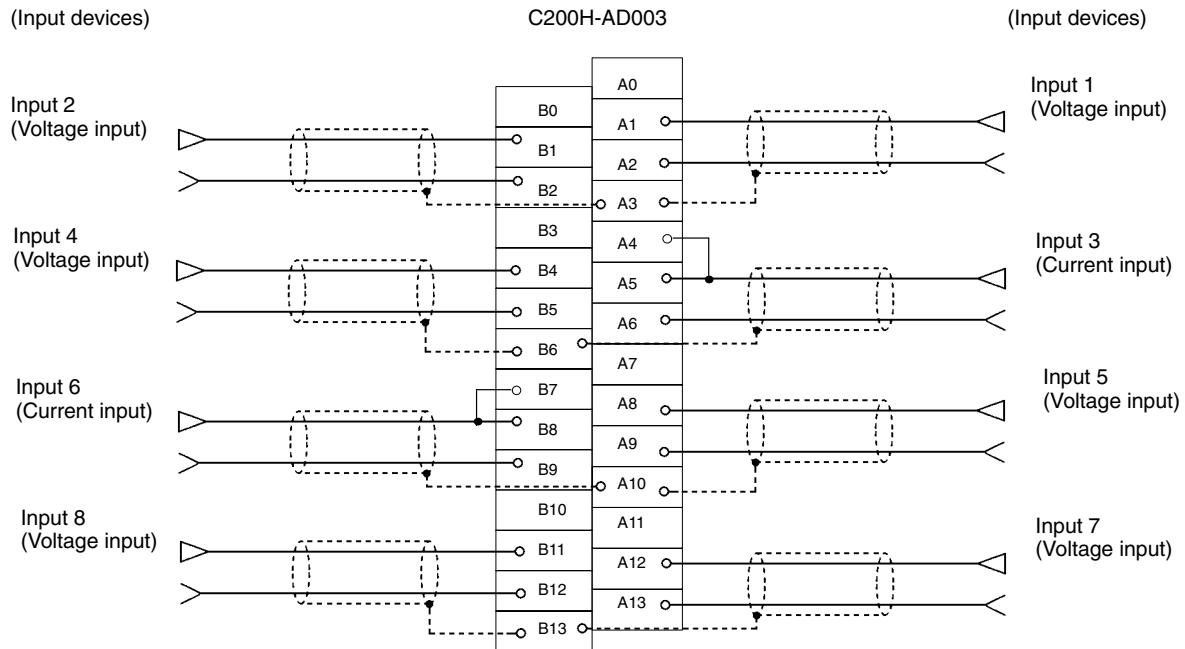

- Note**
1. When using current inputs, the voltage input terminals (V+) and current input terminals (I+) must be individually short-circuited as shown in the above diagram.
 2. For inputs that are not used, either set to "0: Do not use" in the input number settings (refer to 2-5-1 *Setting Inputs and Signal Ranges*) or short-circuit the voltage input terminals (V+) and (V-).
 3. Crimp-type terminals must be used for terminal connections, and the screws must be tightened securely. Use M3 screws and tighten them to a torque of 0.5 N • m.

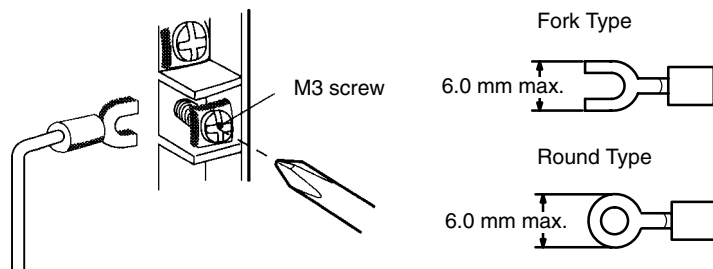

Connecting shielded cable to the Unit's COM terminals (A3, A10, B6, B13) can improve noise resistance.

2-3-5 Input Wiring Considerations

When wiring inputs, apply the following points to avoid noise interference and optimize Analog Input Unit performance.

- Use shielded twisted-pair cable for external connections and power lines.
- Route input cables separately from the AC cable, and do not run the Unit's cables near a main circuit cable, high voltage cable, or a non-PC load cable.
- If there is noise interference from power lines (if, for example, the power supply is shared with electrical welding devices or electrical discharge machines, or if there is a high-frequency generation source nearby) install a noise filter at the power supply input area.

2-4 IR and DM Areas

The IR and DM word addresses that each Analog Input Unit occupies are set by the unit number switch on the front panel of the Unit.

2-4-1 IR Area Allocation and Contents

IR Area Allocation

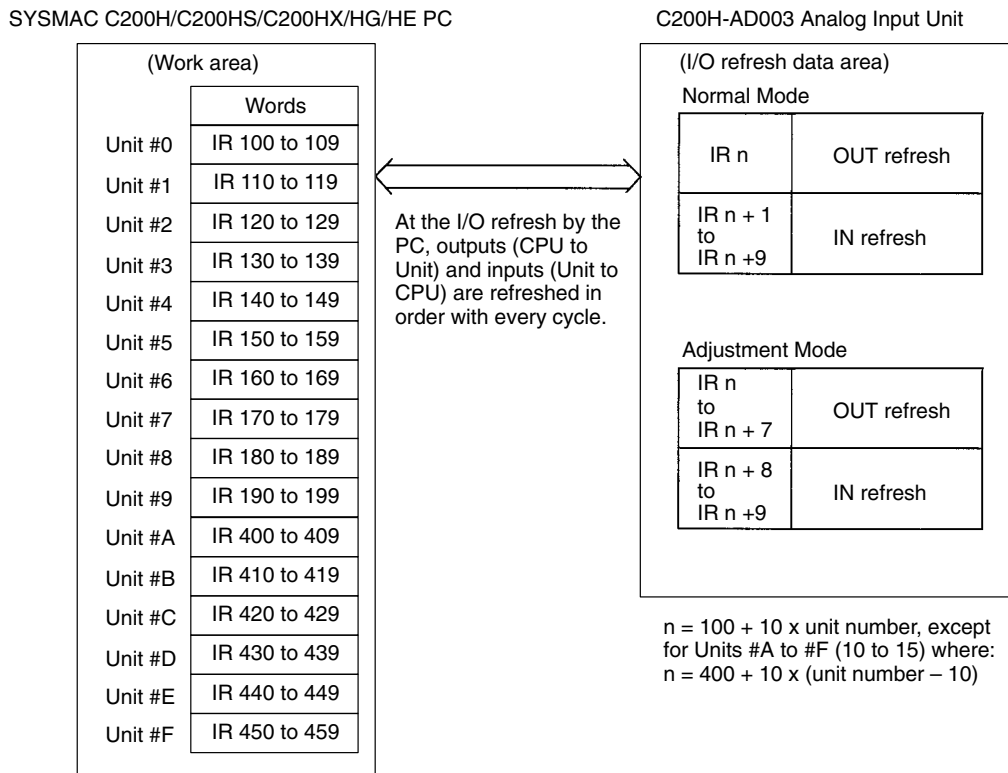

- Note**
1. Switches A to F can be set for the C200HX/HG-CPU5□-E/6□-E. Setting numbers A to F for C200H, C200HS, C200HE, or C200HX/HG-CPU3□-E/4□-E PCs will cause an I/O UNIT OVER error and the Unit will not operate.
 2. If two or more Special I/O Units are assigned the same unit number, an I/O UNIT OVER error will be generated and the PC will not operate.

Allocation for Normal Mode

For normal mode, set the operation mode switch on the rear panel of the Unit as shown in the following diagram.

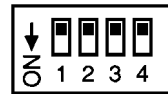

The allocation of IR words and bits is shown in the following table.

I/O	Word	Bits													
		15	14	13	12	11	10	9	8	7	6	5	4	3	2
Output (CPU to Unit)	n	Not used.							Peak value function inputs						
									8	7	6	5	4	3	2
Input (Unit to CPU)	n+1	Input 1 conversion value													
		16 ³				16 ²				16 ¹				16 ⁰	
	n+2	Input 2 conversion value													
	n+3	Input 3 conversion value													
	n+4	Input 4 conversion value													
	n+5	Input 5 conversion value													
	n+6	Input 6 conversion value													
	n+7	Input 7 conversion value													
	n+8	Input 8 conversion value													
	n+9	Error code							Disconnection detection inputs						
16 ¹				16 ⁰			8	7	6	5	4	3	2	1	

Note For the IR word addresses, $n = 100 + 10 \times \text{unit number}$.
 For Units #A to #F (10 to 15), $n = 400 + 10 \times (\text{unit number} - 10)$.

Set Values and Stored Values

Item	Contents
Peak value function	0: Do not use. 1: Use peak value.
Conversion value	16-bit binary data
Disconnection detection	0: No disconnection 1: Disconnection
Error code	Two digits, hexadecimal (00 for no error)

The disconnection detection function can be used when the input signal range is set for 1 to 5 V (4 to 20 mA).

Input signal range	Voltage/current
1 to 5 V	0.3 V max.
4 to 20 mA	1.2 mA max.

Allocation for Adjustment Mode

For adjustment mode, set the operation mode switch on the rear panel of the Unit as shown in the following diagram. When the Unit is set for adjustment mode, the RUN indicator on the front panel of the Unit will flash.

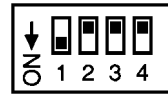

The allocation of IR words and bits is shown in the following table.

I/O	Word	Bits															
		15	14	13	12	11	10	9	8	7	6	5	4	3	2	1	0
Output (CPU to Unit)	n	Not used.								Inputs to be adjusted							
										16 ¹				16 ⁰			
	n+1	Not used.								Not used.		Clr	Set	Not used.		Gain	Off-set
	n+2	Not used.															
	n+3	Not used.															
	n+4	Not used.															
	n+5	Not used.															
	n+6	Not used.															
Input (Unit to CPU)	n+8	Conversion value for adjustment															
		16 ³				16 ²				16 ¹				16 ⁰			
	n+9	Error Code								Disconnection detection inputs							
		16 ¹				16 ⁰				8	7	6	5	4	3	2	1

Note For the IR word addresses, $n = 100 + 10 \times \text{unit number}$.
 For Units #A to #F (10 to 15), $n = 400 + 10 \times (\text{unit number} - 10)$.

Set Values and Stored Values

Item	Contents
Input to be adjusted	Sets input to be adjusted. Leftmost digit: Fixed at 2. Rightmost digit: 1 to 9
Offset (Offset Bit)	When ON, adjusts offset deviation.
Gain (Gain Bit)	When ON, adjusts gain deviation.
Set (Set Bit)	Sets adjusted value and writes to EEPROM.
Clr (Clear Bit)	Clears adjusted value. (Returns to default status)
Conversion value for adjustment	The conversion value for adjustment is stored as 16 bits of binary data.
Disconnection detection	0: No disconnection 1: Disconnection
Error code	Two digits, hexadecimal (00 for no error)

The disconnection detection function can be used when the input signal range is set for 1 to 5 V (4 to 20 mA).

Input signal range	Voltage/current
1 to 5 V	0.3 V max.
4 to 20 mA	1.2 mA max.

2-4-2 DM Allocation and Contents

DM Allocation

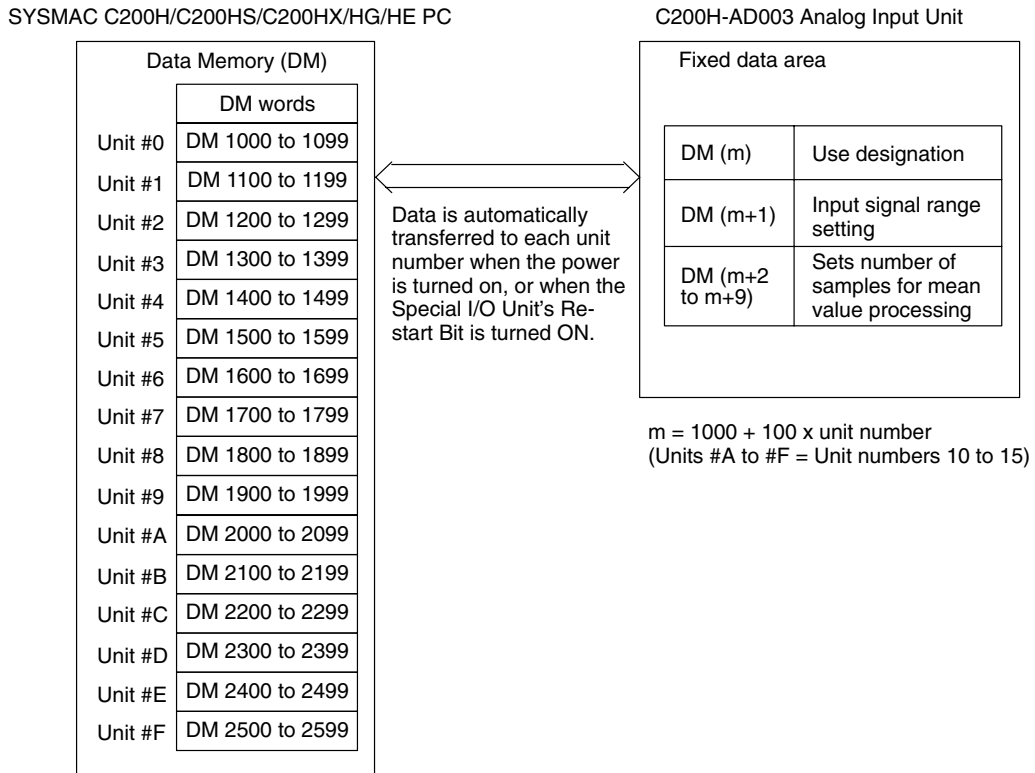

- Note**
- Switches A to F can be set for the C200HX/HG-CPU5□-E/6□-E. Setting numbers A to F for C200H, C200HS, C200HE, or C200HX/HG-CPU3□-E/4□-E PCs will cause an I/O UNIT OVER error and the Unit will not operate.
 - If two or more Special I/O Units are assigned the same unit number, an I/O UNIT OVER error will be generated and the PC will not operate.

DM Allocation Contents

The following table shows the allocation of DM words and bits for both normal and adjustment mode.

DM word	Bits															
	15	14	13	12	11	10	9	8	7	6	5	4	3	2	1	0
DM (m)	Not used.								Use designation inputs							
									8	7	6	5	4	3	2	1
DM (m+1)	Input signal range setting															
	Input 8		Input 7		Input 6		Input 5		Input 4		Input 3		Input 2		Input 1	
DM (m+2)	Mean value processing setting, input 1															
DM (m+3)	Mean value processing setting, input 2															
DM (m+4)	Mean value processing setting, input 3															
DM (m+5)	Mean value processing setting, input 4															
DM (m+6)	Mean value processing setting, input 5															
DM (m+7)	Mean value processing setting, input 6															
DM (m+8)	Mean value processing setting, input 7															
DM (m+9)	Mean value processing setting, input 8															

- Note** For the DM word addresses, m = 1000 + 100 x unit number (Units #A to #F = Unit numbers 10 to 15).

Set Values and Stored Values

Item	Contents
Use designation	0: Do not use. 1: Use.
Input signal range	00: -10 to 10 V 01: 0 to 10 V 10: 1 to 5 V/4 to 20 mA (See note.) 11: Same as for setting "10" above.
Mean value processing setting	0000: No mean value processing 0001: Mean value processing for 2 buffers 0002: Mean value processing for 4 buffers 0003: Mean value processing for 8 buffers 0004: Mean value processing for 16 buffers

Note The input signal range of 1 to 5 V (4 to 20 mA) is switched according to the input terminal connections.

2-5 Using the Functions

2-5-1 Setting Inputs and Signal Ranges

Input Numbers

The Analog Input Unit only converts analog inputs specified by input numbers 1 to 8. In order to specify the analog inputs to be used, turn ON from a Peripheral Device the DM bits shown in the following diagram.

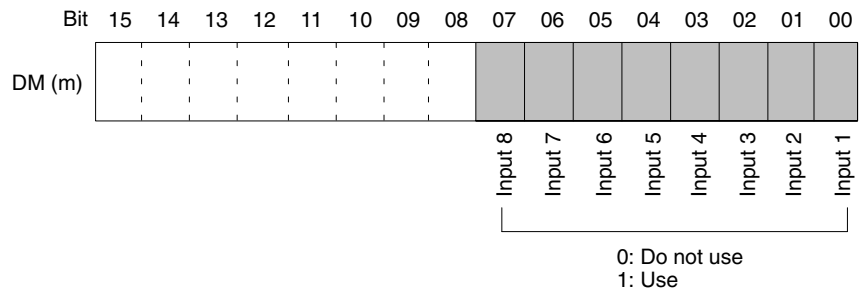

The analog input sampling interval can be shortened by setting any unused input numbers to 0.

$$\text{Sampling interval} = (1 \text{ ms}) \times (\text{Number of inputs used})$$

For the DM word addresses, $m = 1000 + 100 \times \text{unit number}$ (Units #A to #F = Unit numbers 10 to 15).

Input Signal Range

Any of four types of input signal range can be selected for each of the eight inputs (input numbers 1 to 8). In order to specify the input signal range for each input, set from a Peripheral Device the DM bits shown in the following diagram.

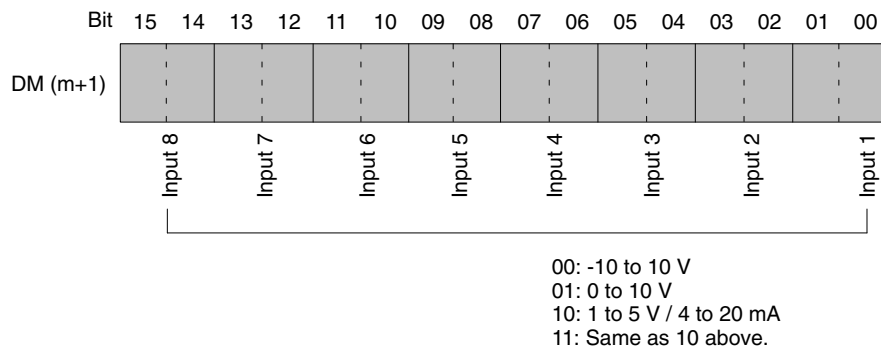

Switching between the options of "1 to 5 V" and "4 to 20 mA" is done by means of the input terminal connections.

For the DM word addresses, $m = 1000 + 100 \times \text{unit number}$ (Units #A to #F = Unit numbers 10 to 15).

Note After making the DM settings from a Peripheral Device, it will be necessary to either power up the PC again or turn ON the Special I/O Unit Restart Bit in order to transfer the contents of the DM settings to the Special I/O Unit. For details regarding the Special I/O Unit Restart Bit, refer to 2-7-4 *Restarting Special I/O Units*.

2-5-2 Reading Conversion Values

Analog input conversion values are stored for each input number, in IR words n+1 through n+8.

Word	Function	Stored value
n+1	Input 1 conversion value	16-bit binary data
n+2	Input 2 conversion value	
n+3	Input 3 conversion value	
n+4	Input 4 conversion value	
n+5	Input 5 conversion value	
n+6	Input 6 conversion value	
n+7	Input 7 conversion value	
n+8	Input 8 conversion value	

For the IR word addresses, $n = 100 + 10 \times \text{unit number}$.
 For Units #A to #F (10 to 15), $n = 400 + 10 \times (\text{unit number} - 10)$.

Use MOV(21) or XFER(70) to read conversion values in the user program.

Example 1

In this example, the conversion data from only one input is read. (The unit number is #0.)

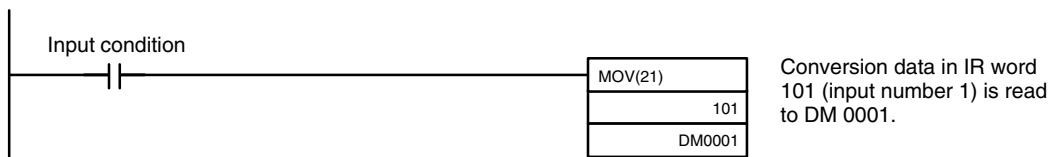

Example 2

In this example, the conversion data from multiple inputs is read. (The unit number is #0.)

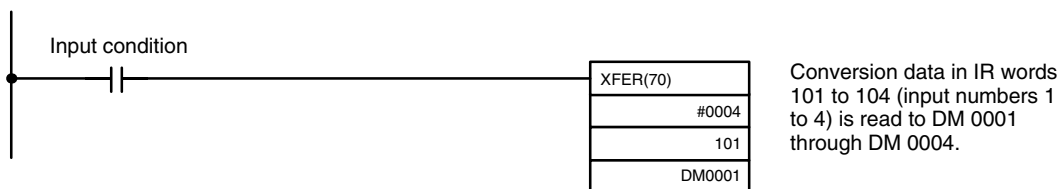

For details regarding conversion value scaling, refer to page 118, *Sample Program 5: Scaling Function*.

2-5-3 Mean Value Processing

The Analog Input Unit can compute the mean value of the conversion values of analog inputs that have been previously sampled. Mean value processing involves an operational mean value in the history buffers, so it has no affect on the data refresh cycle. (The number of history buffers that can be set to use mean value processing is 2, 4, 8, or 16.)

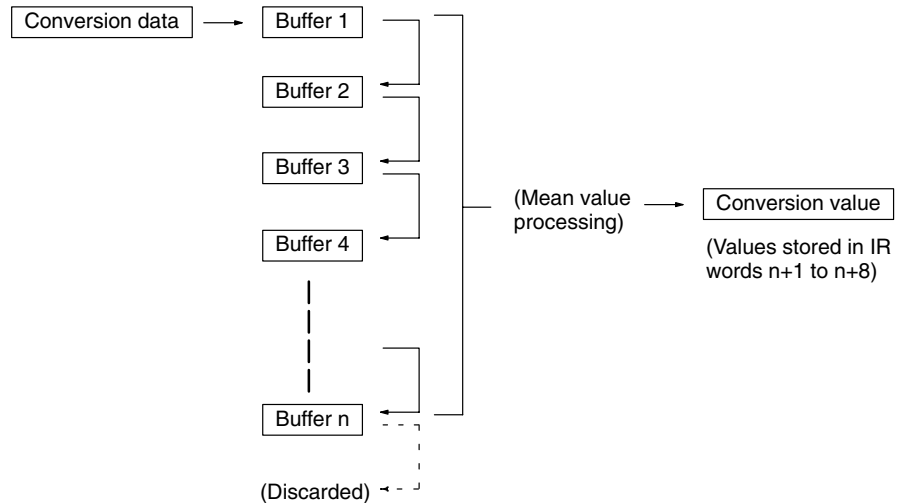

When “n” number of history buffers are being used, the first conversion data will be stored for all “n” number of history buffers immediately data conversion has begun or after a disconnection is restored.

When mean value processing is used together with the peak value function, the mean value will be held.

To specify whether or not mean value processing is to be used, and to specify the number of history buffers for mean data processing, use a Peripheral Device to make the settings in DM m+2 through DM m+9 as shown in the following table.

Word	Function	Set value
DM (m+2)	Input 1 mean value processing	0000: No mean value processing
DM (m+3)	Input 2 mean value processing	0001: Mean value processing with 2 buffers
DM (m+4)	Input 3 mean value processing	0002: Mean value processing with 4 buffers
DM (m+5)	Input 4 mean value processing	0003: Mean value processing with 8 buffers
DM (m+6)	Input 5 mean value processing	0004: Mean value processing with 16 buffers
DM (m+7)	Input 6 mean value processing	
DM (m+8)	Input 7 mean value processing	
DM (m+9)	Input 8 mean value processing	

For the DM word addresses, m = 1000 + 100 x unit number (Units #A to #F = Unit numbers 10 to 15).

Note After making the DM settings from a Peripheral Device, it will be necessary to either power up the PC again or turn ON the Special I/O Unit Restart Bit in order to transfer the contents of the DM settings to the Special I/O Unit. For details regarding the Special I/O Unit Restart Bit, refer to 2-7-4 *Restarting Special I/O Units*.

The history buffer operational means are calculated as shown below. (In this example there are four buffers.)

- 1, 2, 3... 1. With the first cycle, the data is stored with Data 1 being in all the history buffers.

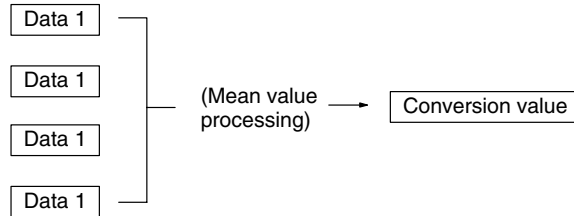

$$\text{Mean value} = (\text{Data 1} + \text{Data 1} + \text{Data 1} + \text{Data 1}) \div 4$$

2. With the second cycle, the data is stored with Data 2 being in the first history buffer.

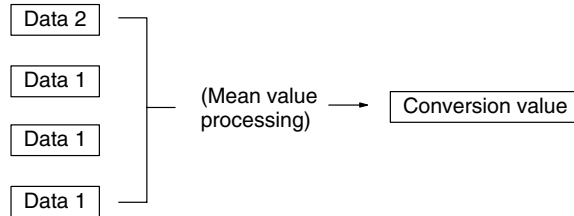

$$\text{Mean value} = (\text{Data 2} + \text{Data 1} + \text{Data 1} + \text{Data 1}) \div 4$$

3. With the third cycle, the data is stored with Data 3 being in the first history buffer.

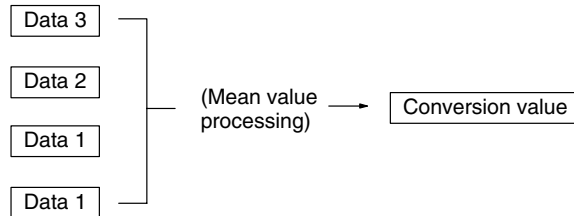

$$\text{Mean value} = (\text{Data 3} + \text{Data 2} + \text{Data 1} + \text{Data 1}) \div 4$$

4. With the fourth cycle, the Data 4 data is stored in the first history buffer.

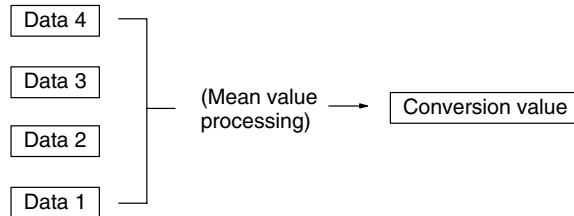

$$\text{Mean value} = (\text{Data 4} + \text{Data 3} + \text{Data 2} + \text{Data 1}) \div 4$$

5. With the fifth cycle, the data is stored with Data 5 being in the first history buffer.

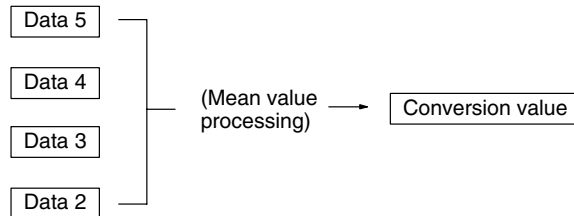

$$\text{Mean value} = (\text{Data 5} + \text{Data 4} + \text{Data 3} + \text{Data 2}) \div 4$$

When a disconnection is restored, the mean value processing function begins again from step 1.

2-5-4 Peak Value Function

The peak value function holds the maximum digital conversion value for every input (including mean value processing). This function can be used with analog input. The following diagram shows how digital conversion values are affected when the peak value function is used.

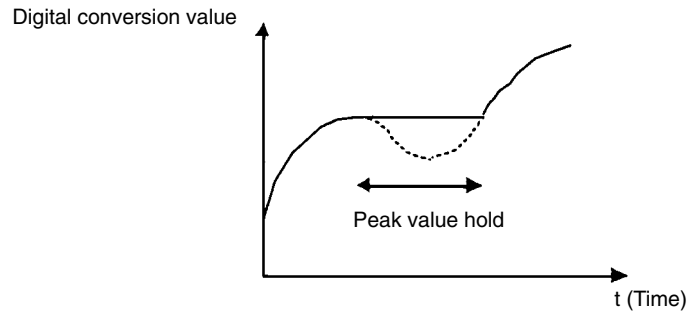

The peak value function can be set individually for each input number by turning on the respective bits (00 to 07) in IR word n.

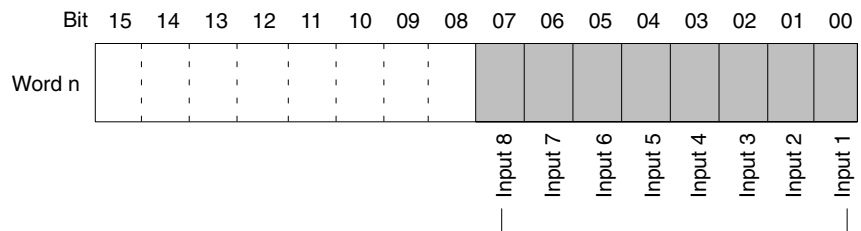

The peak hold function will be in effect for the above input numbers while their respective bits are ON. The conversion values will be reset when the bits are turned OFF.

For the IR word addresses, $n = 100 + 10 \times \text{unit number}$.

For Units #A to #F (10 to 15), $n = 400 + 10 \times (\text{unit number} - 10)$.

In the following example, the peak value function is in effect for input number 1, and the unit number is 0.

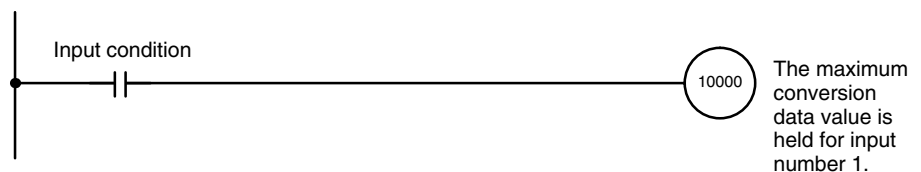

When mean value processing is used together with the peak value function, the mean value will be held.

As long as the peak value function is in effect, the peak value will be held even in the event of a disconnection.

2-5-5 Input Disconnection Detection Function

When an input signal range of 1 to 5 V (4 to 20 mA) is used, input circuit disconnections can be detected. The detection conditions for each of the input signal ranges are shown in the following table.

Range	Current/voltage
1 to 5 V	0.3 V max.
4 to 20 mA	1.2 mA max.

The input disconnection detection signals for each input number are stored in bits 00 to 07 of IR word n+9. Specify these bits as execution conditions in order to use disconnection detection in the user's program.

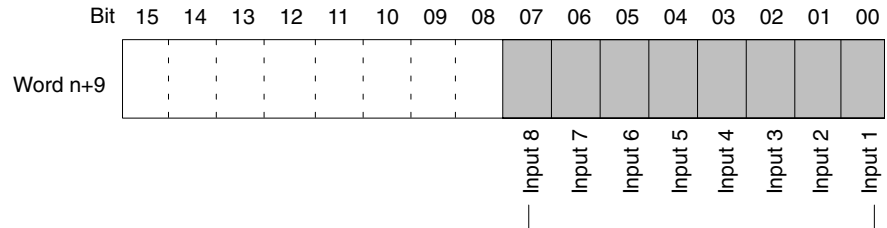

The respective bit turns ON when a disconnection is detected for a given input. When the disconnection is restored, the bit turns OFF.

For the IR word addresses, $n = 100 + 10 \times \text{unit number}$.

For Units #A to #F (10 to 15), $n = 400 + 10 \times (\text{unit number} - 10)$.

The conversion value during a disconnection will be 0000.

Disconnection detection is performed on the input voltage/current data that has been converted into digital values. Therefore, detected values may be different from those shown in the above table due to offset and gain adjustments, etc.

In the following example, the conversion value is read only if there is no disconnection at analog input number 1. (The unit number is 0.)



2-6 Offset and Gain Adjustment

This function is designed to calibrate inputs depending on the devices to be connected.

2-6-1 Adjustment Mode Operational Flow

The following diagram shows the flow of operations when using the adjustment mode for adjusting offset and gain.

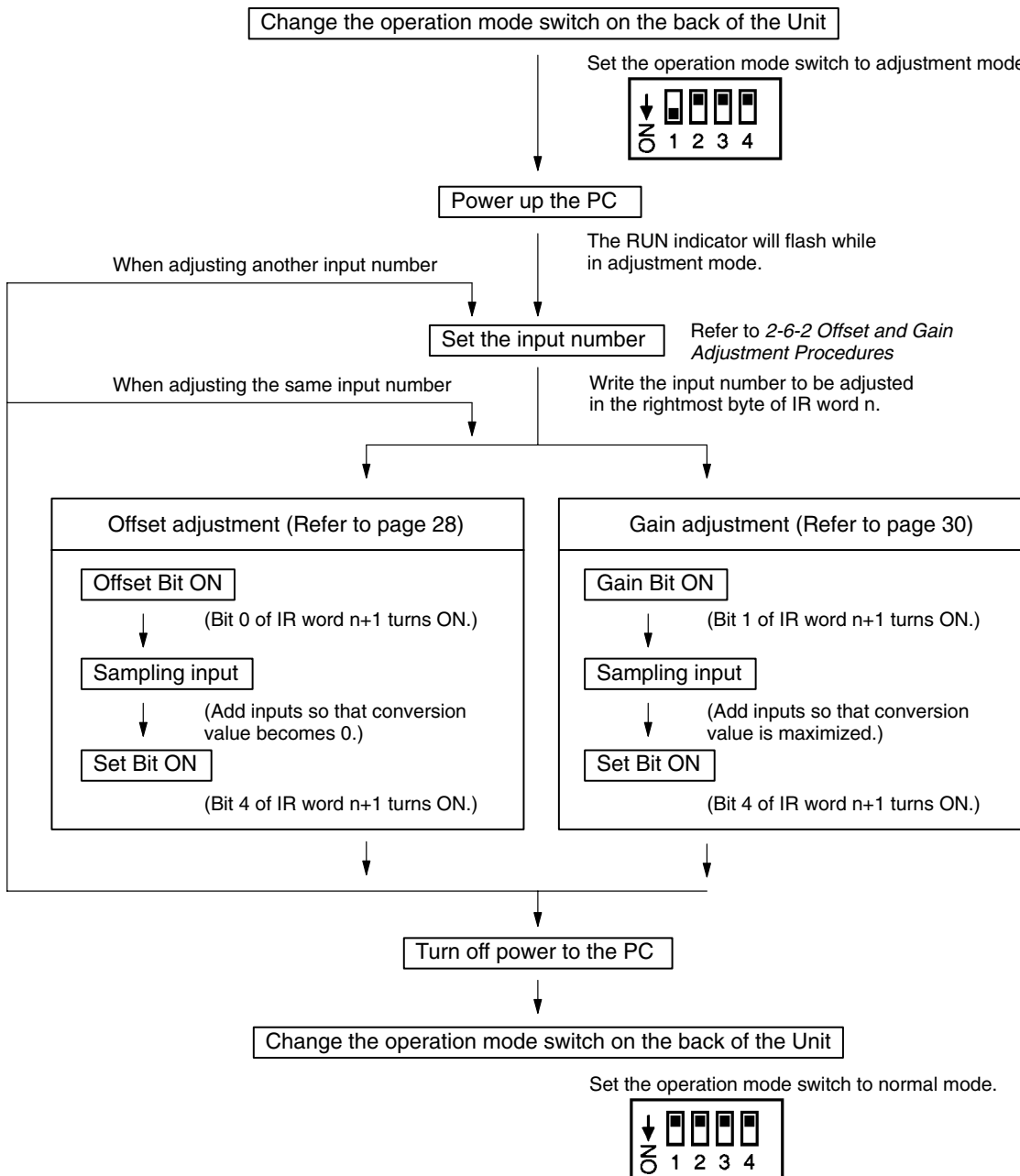

Caution Be sure to turn off the power to the PC before changing the operation mode switch. If the I/O table is registered in the PC, an I/O setting error may occur, not allowing any adjustment. In such a case, either cancel the I/O table or create the I/O table again. When making adjustments, be sure to perform both the offset adjustment and gain adjustment.

Note Input adjustments can be performed more accurately in conjunction with mean value processing.

2-6-2 Offset and Gain Adjustment Procedures

Specifying Input Number to be Adjusted

To specify the input number to be adjusted, write the value to the rightmost byte of IR word n as shown in the following diagram.

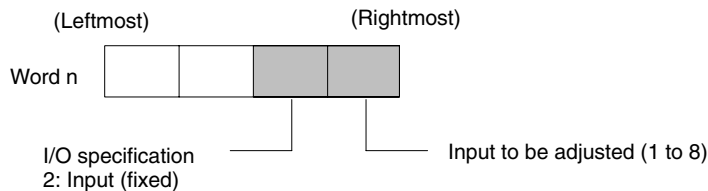

For the IR word addresses, $n = 100 + 10 \times \text{unit number}$.
 For Units #A to #F (10 to 15), $n = 400 + 10 \times (\text{unit number} - 10)$.
 The following example uses input number 1 adjustment for illustration. (The unit number is 0.)

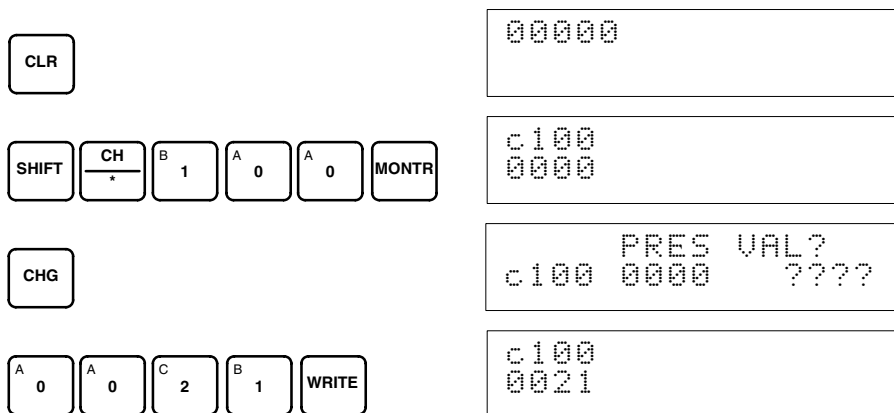

Bits Used for Adjusting Offset and Gain

The IR word n+1 bits shown in the following diagram are used for adjusting offset and gain.

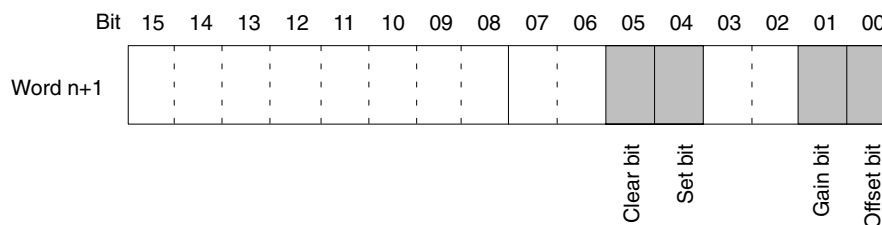

Offset Adjustment

The procedure for adjusting the analog input offset is explained below. As shown in the following diagram, the offset is adjusted by sampling inputs so that the conversion value becomes 0.

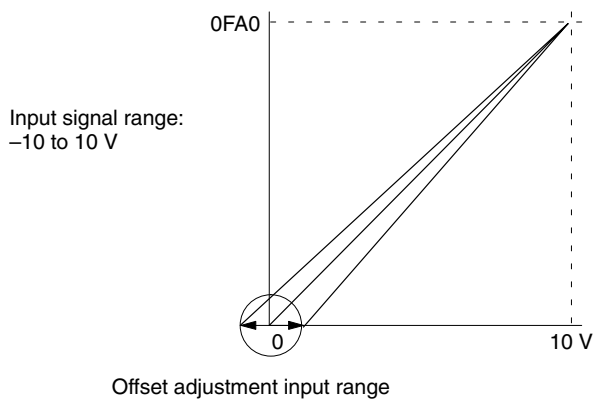

The following example uses input number 1 adjustment for illustration. (The unit number is 0.)

- 1, 2, 3... 1. Turn ON bit 00 (the Offset Bit) of IR word n+1. (Hold the ON status.)

CLR

000000

SHIFT CONT # B 1 A 0 B 1 A 0 A 0 MONTR

10100
^OFF

PLAY SET

10100
■ ON

The analog input's digital conversion values while the Offset Bit is ON will be monitored in IR word n+8.

2. Check whether the input devices are connected.

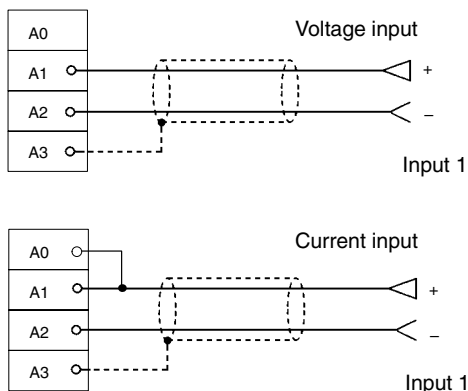

3. Input the voltage or current so that the conversion value becomes 0000. The following table shows the the offset adjustment voltages and currents to be input according to the input signal range.

Input signal range	Input voltage/current	Input range
0 to 10 V	0 V	-0.5 to 0.5 V
-10 to 10 V	0 V	-1.0 to 1.0 V
1 to 5 V	1 V	0.8 to 1.2 V
4 to 20 mA	4 mA	3.2 to 4.8 mA

4. With the voltage or current having been input so that the conversion value for the Analog Input Unit is 0000, turn bit 04 (the Set Bit) of IR word n+1 ON and then OFF again.

SHIFT CONT # B 1 A 0 B 1 A 0 E 4 MONTR

10104 10100
^OFF ^ ON

PLAY SET

10104 10100
■ ON ^ ON

REC RESET

10104 10100
■ OFF ^ ON

While the Offset Bit is ON, the offset value will be saved to the Unit's EEPROM when the Set Bit turns ON.

- To finish the offset adjustment, turn OFF bit 00 (the Offset Bit) of IR word n+1.



```
10100 10104
^ ON ^OFF
```



```
10100 10104
■ OFF ^OFF
```

Caution Do not turn OFF the power supply or restart the Unit while the Set Bit is ON (data is being written to the EEPROM). Otherwise, illegal data may be written in the Unit's EEPROM and "Special I/O Unit Errors" may occur when the power supply is turned ON or when the Unit is restarted, causing a malfunction. When making adjustments, be sure to perform both the offset adjustment and gain adjustment.

Note The EEPROM can be overwritten 50,000 times.

Gain Adjustment

The procedure for adjusting the analog input gain is explained below. As shown in the following diagram, the gain is adjusted by sampling inputs so that the conversion value is maximized.

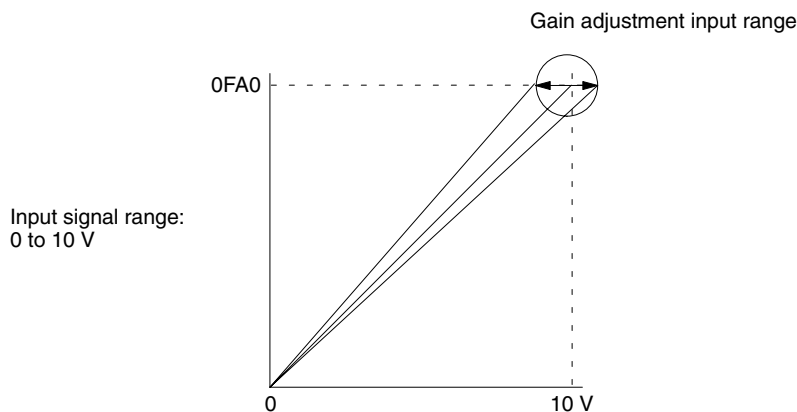

The following example uses input number 1 adjustment for illustration. (The unit number is 0.)

1. Turn ON bit 01 (the Gain Bit) of IR word n+1. (Hold the ON status.)



```
10101
^OFF
```



```
10101
■ ON
```

The analog input's digital conversion values while the Gain Bit is ON will be monitored in IR word n+8.

2. Check whether the input devices are connected.

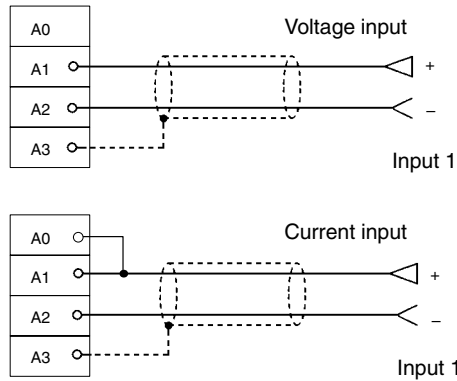

3. Input the voltage or current so that the conversion value is maximized (0FA0 or 07D0). The following table shows the the gain adjustment voltages and currents to be input according to the input signal range.

Input signal range	Input voltage/current	Input range
0 to 10 V	10 V	9.5 to 10.5 V
-10 to 10 V	10 V	9.0 to 11.0 V
1 to 5 V	5 V	4.8 to 5.2 V
4 to 20 mA	20 mA	19.2 to 20.8 mA

4. With the voltage or current having been input so that the conversion value for the Analog Input Unit is maximized (0FA0 or 07D0), turn bit 04 (the Set Bit) of IR word n+1 ON and then OFF again.



```
10104 10101
^OFF ^ ON
```



```
10104 10101
■ ON ^ ON
```



```
10104 10101
■OFF ^ ON
```

While the Gain Bit is ON, the gain value will be saved to the Unit's EEPROM when the Set Bit turns ON.

5. To finish the gain adjustment, turn OFF bit 01 (the Gain Bit) of IR word n+1.



```
10101 10104
^ ON ^OFF
```



```
10101 10104
■ OFF ^OFF
```

Caution Do not turn OFF the power supply or restart the Unit while the Set Bit is ON (data is being written to the EEPROM). Otherwise, illegal data may be written in the Unit's EEPROM and "Special I/O Unit Errors" may occur when the power supply is turned ON or when the Unit is restarted, causing a malfunction. When making adjustments, be sure to perform both the offset adjustment and gain adjustment.

Note The EEPROM can be overwritten 50,000 times.

Clearing Offset and Gain Adjusted Values

Follow the procedure outlined below to return the offset and gain adjusted values to their default settings.

The following example uses input number 1 adjustment for illustration. (The unit number is 0.)

- 1, 2, 3... 1. Turn ON bit 05 (the Clear Bit) of IR word n+1. (Hold the ON status.) Regardless of the input value, 0000 will be monitored in IR word n+8.



```
10105
^OFF
```



```
10105
■ ON
```

2. Turn bit 04 of IR word n+1 ON and then OFF again.

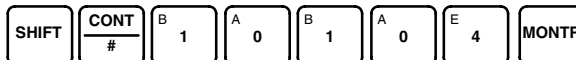

```
10104 10105
^OFF ^ ON
```



```
10104 10105
■ ON ^ ON
```



```
10104 10105
■ OFF ^ ON
```

While the Clear Bit is ON, the default offset and gain values will be saved to the Unit's EEPROM when the Set Bit turns ON.

3. To finish the clearing of adjusted values, turn OFF bit 05 (the Clear Bit) of IR word n+1.



```
10105 10104
^ ON ^OFF
```



```
10105 10104
■ OFF ^OFF
```

Caution Do not turn OFF the power supply or restart the Unit while the Set Bit is ON (data is being written to the EEPROM). Otherwise, illegal data may be written in the Unit's EEPROM and "Special I/O Unit Errors" may occur when the power supply is turned ON or when the Unit is restarted, causing a malfunction.

Note The EEPROM can be overwritten 50,000 times.

2-7 Error Processing

2-7-1 Troubleshooting Procedure

Use the following procedure for troubleshooting Analog Input Unit errors.

- 1, 2, 3...**
1. Error occurs.
 2. Is the ERROR indicator lit?
 - Yes: Error detected by Analog Input Unit
(Refer to 2-7-2 Errors Detected by Analog Input Unit.)
 - No: Go to the next step.
 3. Is the RUN indicator lit?
 - Yes: Error detected by CPU Unit
(Refer to 2-7-3 Errors Detected by CPU Unit.)
Check whether the operation mode switch on the back of the Analog Input Unit is set correctly.
 - No: Refer to 2-7-5 Troubleshooting.

If both the ERROR and RUN indicators are lit, check whether the operation mode switch on the back of the Analog Input Unit is set correctly.

2-7-2 Errors Detected by Analog Input Unit

When an error occurs at the Analog Input Unit, the ERROR indicator on the front panel of the Unit lights and the error code is stored in bits 08 to 15 of IR word n+9.

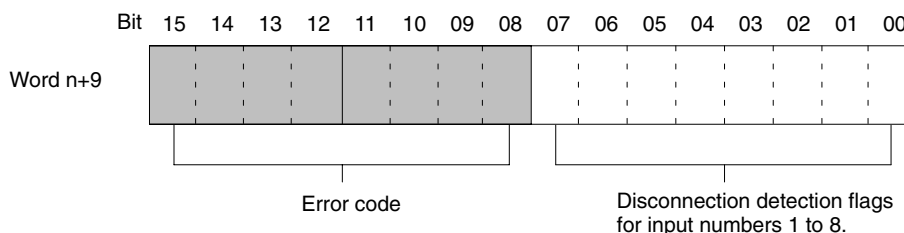

For the IR word addresses, $n = 100 + 10 \times \text{unit number}$.
 For Units #A to #F (10 to 15), $n = 400 + 10 \times (\text{unit number} - 10)$.

Error code		Error contents	Countermeasure
8	0	In adjustment mode, offset or gain cannot be adjusted because input value is out of the permissible range for adjustment.	If making the adjustment by means of a connected input device, first adjust the input device before adjusting the Analog Input Unit.
8	1	In adjustment mode, adjustment cannot be performed because the specified input number is not set for use or because the wrong input number is specified.	Check whether the word n input number to be adjusted is set from 21 to 28. Check whether the input number to be adjusted is set for use by means of the DM setting.
8	2	A disconnection was detected. (See note.)	Check the rightmost byte of IR word n+9. The inputs for bits that are ON may be disconnected. Restore any disconnected inputs.
8	8	An EEPROM writing error has occurred while in adjustment mode.	Turn the Set Bit OFF, ON, and OFF again. If the error persists even after the reset, replace the Analog Input Unit.
F	3	The wrong number of samplings has been specified for mean processing.	Specify a number from 0000 to 0004.

Note Disconnection detection (82) operates for input numbers used with a range of 1 to 5 V (4 to 20 mA).
 Errors indicated with 8□ codes are automatically reset when proper countermeasures are taken. The errors indicated with F□ codes are cleared when the power is turned on after making the correct settings and when the Special I/O Unit Restart Bit is turned OFF, ON, and OFF again.

2-7-3 Errors Detected by CPU Unit

When the CPU Unit detects an error at a Special I/O Unit, it outputs to the CPU Unit's SR and AR areas as shown below.

Special I/O Unit Error Flag

Bit	Error	Contents	CPU Unit status	LED indicators
25415	I/O UNIT OVER	The same unit number has been set for more than one Special I/O Unit.	CPU Unit operation is stopped.	RUN: Not lit ERROR: Not lit
	SPECIAL I/O UNIT ERROR	Error occurred in I/O refresh between Special I/O Unit and CPU Unit.	Operation is stopped only for faulty Unit.	RUN: Not lit ERROR: Not lit

Special I/O Unit Error Flags

Bits		Functions	
C200HX/HG/HE			
	C200H/HS		
28200	AR 0000	Unit #0 Error Flag	Turns ON for any unit number when I/O UNIT OVER or SPECIAL I/O UNIT ERROR occurs.
28201	AR 0001	Unit #1 Error Flag	
28202	AR 0002	Unit #2 Error Flag	
28203	AR 0003	Unit #3 Error Flag	
28204	AR 0004	Unit #4 Error Flag	
28205	AR 0005	Unit #5 Error Flag	
28206	AR 0006	Unit #6 Error Flag	
28207	AR 0007	Unit #7 Error Flag	
28208	AR 0008	Unit #8 Error Flag	
28209	AR 0009	Unit #9 Error Flag	
28210 (See note.)	---	Unit #A Error Flag	
28211 (See note.)	---	Unit #B Error Flag	
28212 (See note.)	---	Unit #C Error Flag	
28213 (See note.)	---	Unit #D Error Flag	
28214 (See note.)	---	Unit #E Error Flag	
28215 (See note.)	---	Unit #F Error Flag	

Note SR bits 28210 to 28215 cannot be used with C200HE and C200HX/HG-CPU3□-E/4□-E PCs.

2-7-4 Restarting Special I/O Units

There are two ways to restart Special I/O Unit operation after having changed DM contents or having corrected the cause of an error. The first way is to power up the PC again, and the second way is to turn the Special I/O Unit Restart Bit ON and then OFF again.

Special I/O Unit Restart Bits

Bits		Functions	
C200HX/HG/HE			
	C200H/HS		
28100	AR 0100	Unit #0 Restart Bit	Turning the Restart Bit for any Unit ON and then OFF again restarts that Unit.
28101	AR 0101	Unit #1 Restart Bit	
28102	AR 0102	Unit #2 Restart Bit	
28103	AR 0103	Unit #3 Restart Bit	
28104	AR 0104	Unit #4 Restart Bit	
28105	AR 0105	Unit #5 Restart Bit	
28106	AR 0106	Unit #6 Restart Bit	
28107	AR 0107	Unit #7 Restart Bit	
28108	AR 0108	Unit #8 Restart Bit	
28109	AR 0109	Unit #9 Restart Bit	
28110 (See note.)	---	Unit #A Restart Bit	
28111 (See note.)	---	Unit #B Restart Bit	
28112 (See note.)	---	Unit #C Restart Bit	
28113 (See note.)	---	Unit #D Restart Bit	
28114 (See note.)	---	Unit #E Restart Bit	
28115 (See note.)	---	Unit #F Restart Bit	

Note SR bits 28210 to 28215 cannot be used with C200HE and C200HX/HG-CPU3□-E/4□-E PCs.

If the error is not cleared even after turning the Special I/O Unit Restart Bit ON and then OFF again, then replace the Unit.

2-7-5 Troubleshooting

The following tables explain the probable causes of troubles that may occur, and the countermeasures for dealing with them.

Conversion Data Does Not Change

Probable cause	Countermeasure	Page
The input is not set for being used.	Set the input to be used.	21
The peak value function is in operation.	Turn off the peak value function if it is not required.	25
The input device is not working, the input wiring is wrong, or there is a disconnection.	Using a tester, check to see if the input voltage or current is changing.	16
	Use Unit's error codes to check for a disconnection.	25, 34

Value Does Not Change as Intended

Probable cause	Countermeasure	Page
The input device's signal range does not match the input signal range for the relevant input number at the Analog Input Unit.	Check the specifications of the input device, and match the settings for the input signal ranges.	21
The offset and gain are not adjusted.	Adjust the offset and gain.	27
When using the 4 mA to 20 mA range, the voltage input (+) terminal and the current input (+) terminal are not connected.	Connect the terminals.	16

Conversion Values are Inconsistent

Probable cause	Countermeasure	Page
The input signals are being affected by external noise.	Change the shielded cable connection to the Unit's COM terminal.	16
	Insert a 0.01- μ F to 0.1- μ F ceramic capacitor or film capacitor between the input's (+) and (-) terminals.	---
	Try increasing the number of mean value processing buffers.	23

SECTION 3

C200H-DA003 and C200H-DA004 Analog Output Units

This section provides the information required to install and operate a C200H-DA003 or C200H-DA004 Analog Output Unit.

3-1	Specifications	38
3-1-1	General Specifications	38
3-1-2	Performance Specifications	38
3-1-3	Output Specifications	39
3-2	Nomenclature and Functions	40
3-2-1	Indicators	41
3-2-2	Unit Number Switch	41
3-2-3	Operation Mode Switch	42
3-3	Wiring	42
3-3-1	Terminal Arrangement	42
3-3-2	Internal Circuitry	43
3-3-3	Output Wiring Examples	44
3-3-4	Output Wiring Considerations	45
3-4	IR and DM Areas	46
3-4-1	IR Area Allocation and Contents	46
3-4-2	DM Allocation and Contents	49
3-5	Using the Functions	50
3-5-1	Setting Outputs and Signal Ranges	50
3-5-2	Output Hold Function	51
3-5-3	Writing Set Values	52
3-5-4	Starting and Stopping Conversion	52
3-5-5	Output Setting Errors	53
3-6	Offset and Gain Adjustment	54
3-6-1	Adjustment Mode Operational Flow	54
3-6-2	Offset and Gain Adjustment Procedures	55
3-7	Error Processing	62
3-7-1	Troubleshooting Procedure	62
3-7-2	Errors Detected by Analog Output Unit	62
3-7-3	Errors Detected by CPU Unit	63
3-7-4	Restarting Special I/O Units	63
3-7-5	Troubleshooting	64

3-1 Specifications

3-1-1 General Specifications

All general specifications of the C200H-DA003/DA004 Analog Output Units conform to those of the C200H, C200HS, and C200HX/HG/HE Series.

3-1-2 Performance Specifications

Item		C200H-DA003	C200H-DA004
Number of analog outputs		8	
Output signal range (note 1)		0 to 10 V -10 to 10 V 1 to 5 V	4 to 20 mA
Output impedance		0.5 Ω max.	---
Max. output current		12 mA	---
Max. load resistance		---	600 Ω max.
Resolution		1/4000 (full scale)	
Set data		16-bit binary data	
Accuracy (note 2)	23 $^{\circ}$ \pm 2 $^{\circ}$ C	\pm 0.3% of full scale	\pm 0.5% of full scale
	0 $^{\circ}$ to 55 $^{\circ}$ C	\pm 0.5% of full scale	\pm 0.8% of full scale
Conversion time (note 3)		1.0 ms/point	
Isolation		Between input terminals and PC: photocoupler (No isolation between individual output signals.)	
External connectors		28-point terminal block (M3 screws)	
Power consumption		100 mA max. at 5 VDC	
		200 mA max. at 26 VDC	250 mA max. at 26 VDC
Dimensions		34.5 x 130 x 128 (W x H x D) mm (refer to <i>Appendix A Dimensions</i>)	
Weight		450 g max.	

- Note**
- The output signal range can be set individually for each output.
 - The accuracy is given for full scale. For example, an accuracy of \pm 0.3% means a maximum error of \pm 12 (BCD).
 - This is the time required for converting and outputting the PC data. It takes at least one cycle for the data stored in the PC to be read by the Analog Output Unit.
By executing an I/O refresh, the conversion time may be extended by an additional 0.3 ms approximately.
 - The default setting for the load resistance of the C200H-DA004 is 250 Ω . When using a load resistance other than 250 Ω , perform the offset and gain adjustment as required.

3-1-3 Output Specifications

Range: 1 to 5 V (4 to 20 mA)

Analog output signal

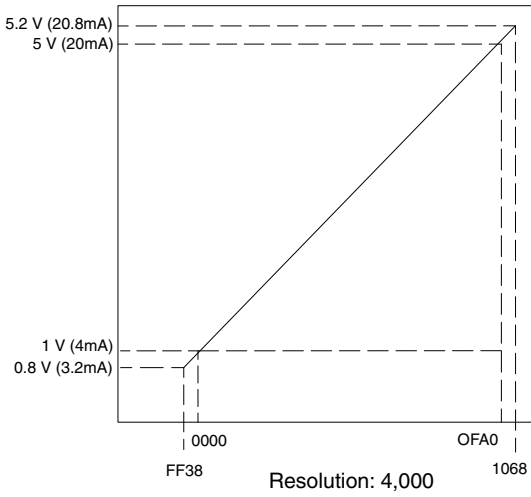

Set value (16-bit binary data)

Range: 0 to 10 V

Analog output signal

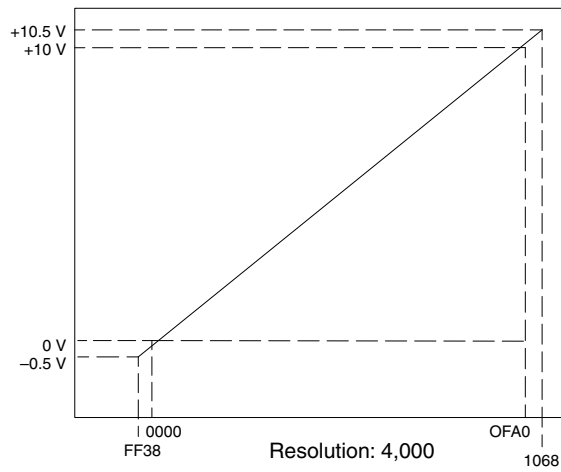

Set value (16-bit binary data)

Range: -10 to 10 V

Analog output signal

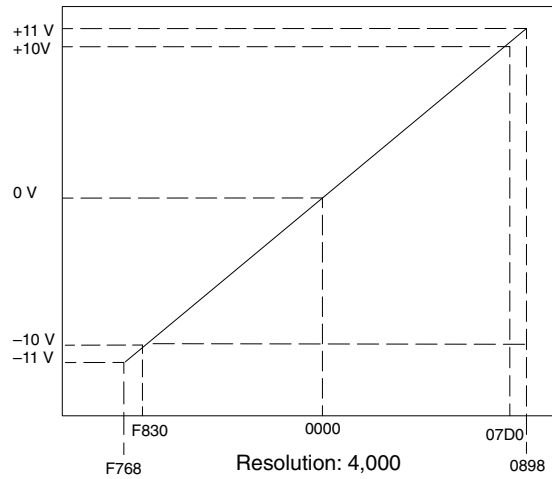

Set value (16-bit binary data)

3-2 Nomenclature and Functions

The model shown here is the C200H-DA003

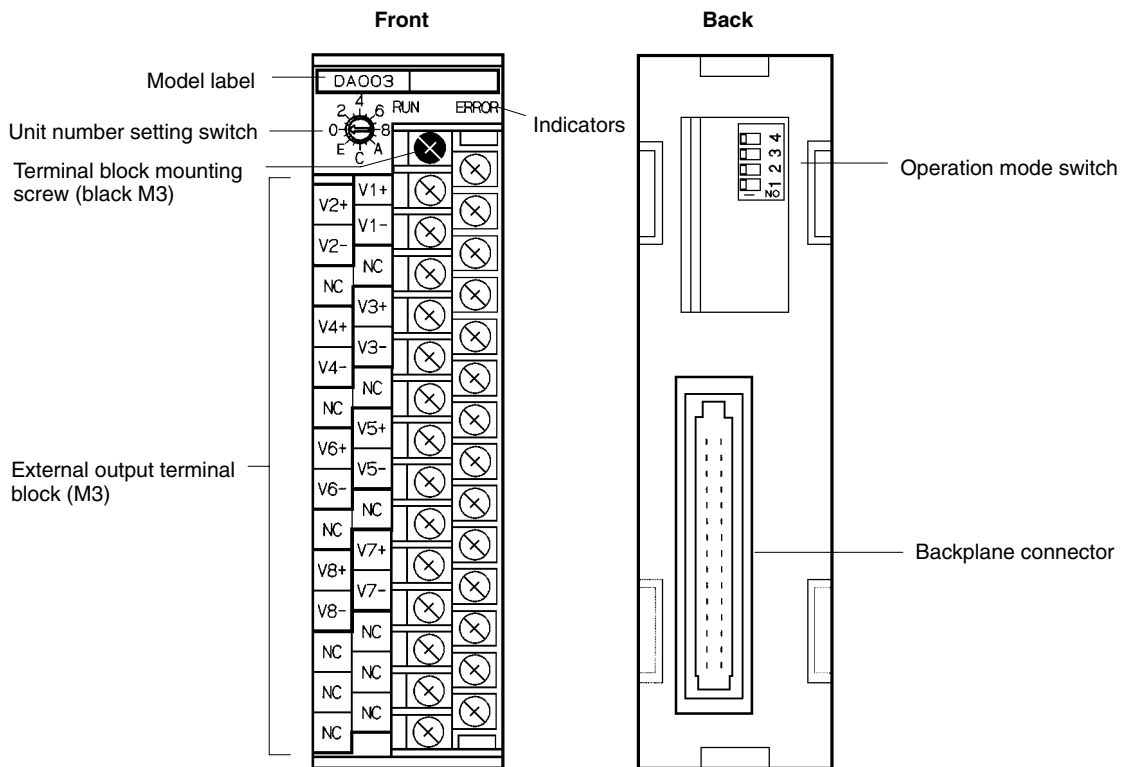

The terminal block is attached by a connector. It can be removed by loosening the black mounting screw. When removing the terminal block after wiring, remove the wire connected to the top terminal of the right column.

Check to be sure that the black terminal block mounting screw is securely tightened to a torque of 0.5 N • m.

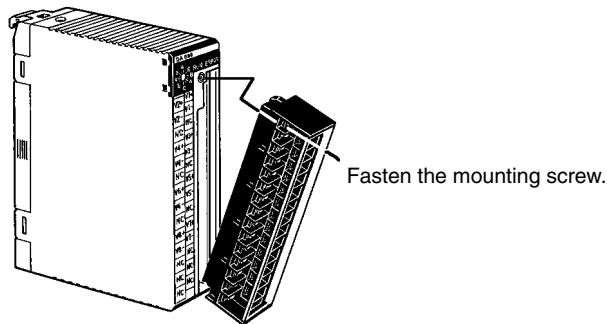

3-2-1 Indicators

The RUN and ERROR indicators show the operating status of the Unit. The following table shows the meanings of the indicators.

LED	Indicator	Operating status
RUN (green)	Lit	Operating in normal mode.
	Flashes	Operating in adjustment mode.
	Not lit	Abnormal (Unit operation stopped)
ERROR (red)	Lit	Error occurred. The error codes are stored in bits 08 to 15 of word n+9.
	Not lit	Other than the above.

3-2-2 Unit Number Switch

The CPU Unit and Analog Output Unit exchange data via the IR area and the DM area. The IR and DM word addresses that each Analog Input Unit occupies are set by the unit number switch on the front panel of the Unit.

Always turn off the power before setting the unit number. Use a flat-blade screwdriver, being careful not to damage the slot in the screw. Be sure not to leave the switch midway between settings.

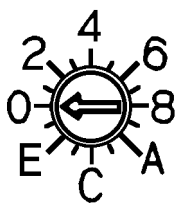

Switch setting	Unit number	IR words	DM words
0	Unit #0	IR 100 to 109	DM 1000 to 1099
1	Unit #1	IR 110 to 119	DM 1100 to 1199
2	Unit #2	IR 120 to 129	DM 1200 to 1299
3	Unit #3	IR 130 to 139	DM 1300 to 1399
4	Unit #4	IR 140 to 149	DM 1400 to 1499
5	Unit #5	IR 150 to 159	DM 1500 to 1599
6	Unit #6	IR 160 to 169	DM 1600 to 1699
7	Unit #7	IR 170 to 179	DM 1700 to 1799
8	Unit #8	IR 180 to 189	DM 1800 to 1899
9	Unit #9	IR 190 to 199	DM 1900 to 1999
A	Unit #A	IR 400 to 409	DM 2000 to 2099
B	Unit #B	IR 410 to 419	DM 2100 to 2199
C	Unit #C	IR 420 to 429	DM 2200 to 2299
D	Unit #D	IR 430 to 439	DM 2300 to 2399
E	Unit #E	IR 440 to 449	DM 2400 to 2499
F	Unit #F	IR 450 to 459	DM 2500 to 2599

Note 1. Switches A to F can be set for the C200HX/HG-CPU5□-E/6□-E. Setting numbers A to F for C200H, C200HS, C200HE, or C200HX/HG-CPU3□-E/4□-E PCs will cause an I/O UNIT OVER error and the Unit will not operate.

2. If two or more Special I/O Units are assigned the same unit number, an I/O UNIT OVER error will be generated and the PC will not operate.

3-2-3 Operation Mode Switch

The operation mode switch on the back of the Unit is used to set the operation mode to either normal mode or adjustment mode (for adjusting offset and gain).

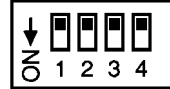

Pin number				Mode
1	2	3	4	
OFF	OFF	OFF	OFF	Normal mode
ON	OFF	OFF	OFF	Adjustment mode

Caution Do not set the pins to any combination other than those shown in the above table. Be sure to set pins 2, 3, and 4 to OFF.

Caution Be sure to turn off the power to the PC before changing the operation mode switch settings.

3-3 Wiring

3-3-1 Terminal Arrangement

The signal names corresponding to the connecting terminals are as shown in the following diagram.

Voltage Output Model (C200H-DA003)

Voltage output 2 (+)	B0	A0	Voltage output 1 (+)
Voltage output 2 (-)	B1	A1	Voltage output 1 (-)
NC	B2	A2	NC
Voltage output 4 (+)	B3	A3	Voltage output 3 (+)
Voltage output 4 (-)	B4	A4	Voltage output 3 (-)
NC	B5	A5	NC
Voltage output 6 (+)	B6	A6	Voltage output 5 (+)
Voltage output 6 (-)	B7	A7	Voltage output 5 (-)
NC	B8	A8	NC
Voltage output 8 (+)	B9	A9	Voltage output 7 (+)
Voltage output 8 (-)	B10	A10	Voltage output 7 (-)
NC	B11	A11	NC
NC	B12	A12	NC
NC	B13	A13	NC

Current Output Model (C200H-DA004)

NC	B0	A0	NC
Current output 2 (-)	B1	A1	Current output 1 (-)
Current output 2 (+)	B2	A2	Current output 1 (+)
NC	B3	A3	NC
Current output 4 (-)	B4	A4	Current output 3 (-)
Current output 4 (+)	B5	A5	Current output 3 (+)
NC	B6	A6	NC
Current output 6 (-)	B7	A7	Current output 5 (-)
Current output 6 (+)	B8	A8	Current output 5 (+)
NC	B9	A9	NC
Current output 8 (-)	B10	A10	Current output 7 (-)
Current output 8 (+)	B11	A11	Current output 7 (+)
NC	B12	A12	NC
NC	B13	A13	NC

- Note**
1. The analog output numbers that can be used are set in the Data Memory (DM).
 2. The output signal ranges for individual outputs are set in the Data Memory (DM). Setting is possible for every Analog Output Unit output number.

3-3-2 Internal Circuitry

The following diagrams show the internal circuitry of the analog output section.

Voltage Output Model (C200H-DA003)

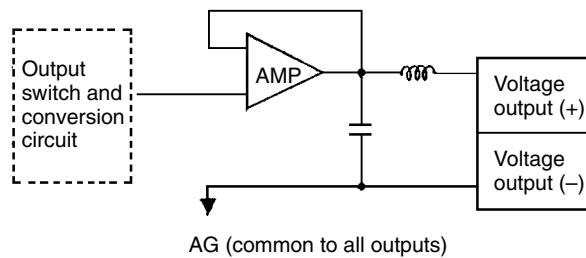

Current Output Model (C200H-DA004)

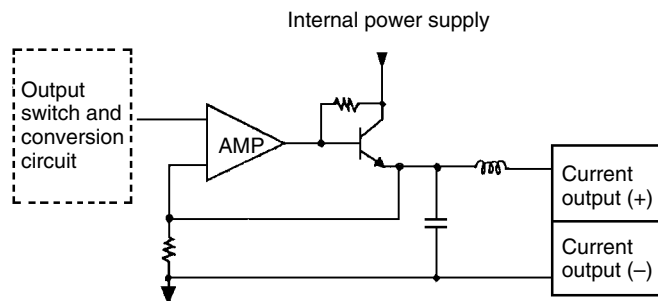

3-3-3 Output Wiring Examples

Voltage Output Model (C200H-DA003)

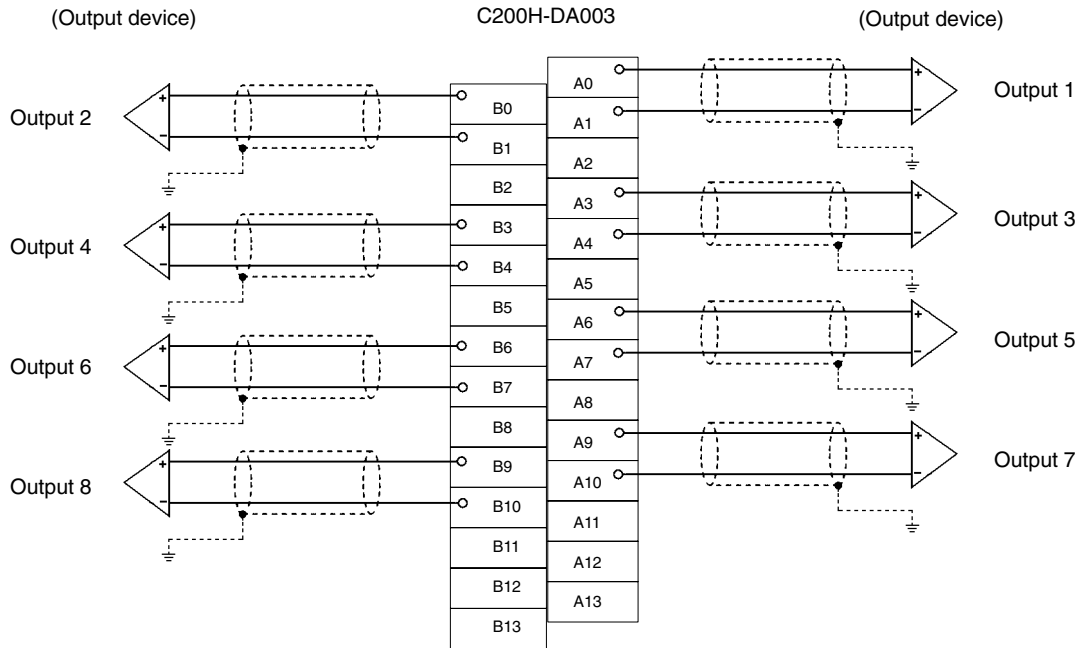

Current Output Model (C200H-DA004)

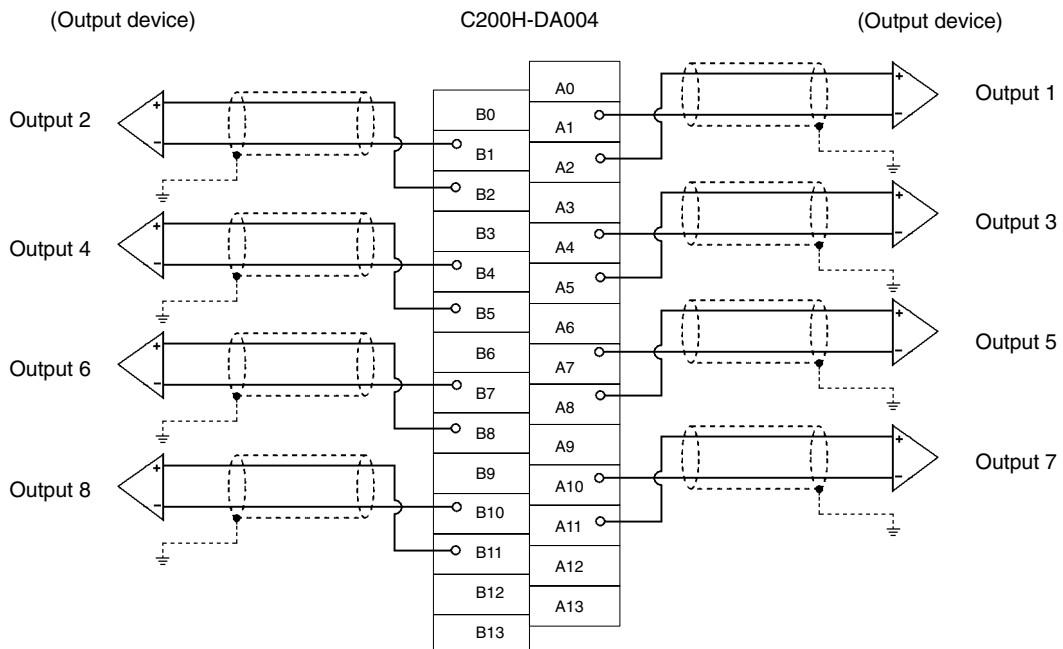

Note Crimp-type terminals must be used for terminal connections, and the screws must be tightened securely. Use M3 screws and tighten them to a torque of 0.5 N • m.

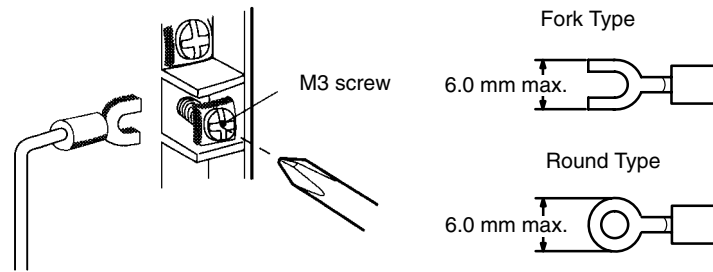

To minimize output wiring noise, ground the output signal line to the output device.

3-3-4 Output Wiring Considerations

When wiring outputs, apply the following points to avoid noise interference and optimize Analog Output Unit performance.

- Use shielded twisted-pair cable for external connections.
- Route output cables separately from the AC cable, and do not run the Unit's cables near a main circuit cable, high voltage cable, or a non-PC load cable.
- If there is noise interference from power lines (if, for example, the power supply is shared with electrical welding devices or electrical discharge machines, or if there is a high-frequency generation source nearby) install a noise filter at the power supply output area.
- When the power supply to the PC is turned on or off, momentary voltage or current may be output from the output terminal.

3-4 IR and DM Areas

The IR and DM word addresses that each Analog Output Unit occupies are set by the unit number switch on the front panel of the Unit. (For details on setting the unit number, refer to 3-2-2 Unit Number Switch.)

3-4-1 IR Area Allocation and Contents

IR Area Allocation

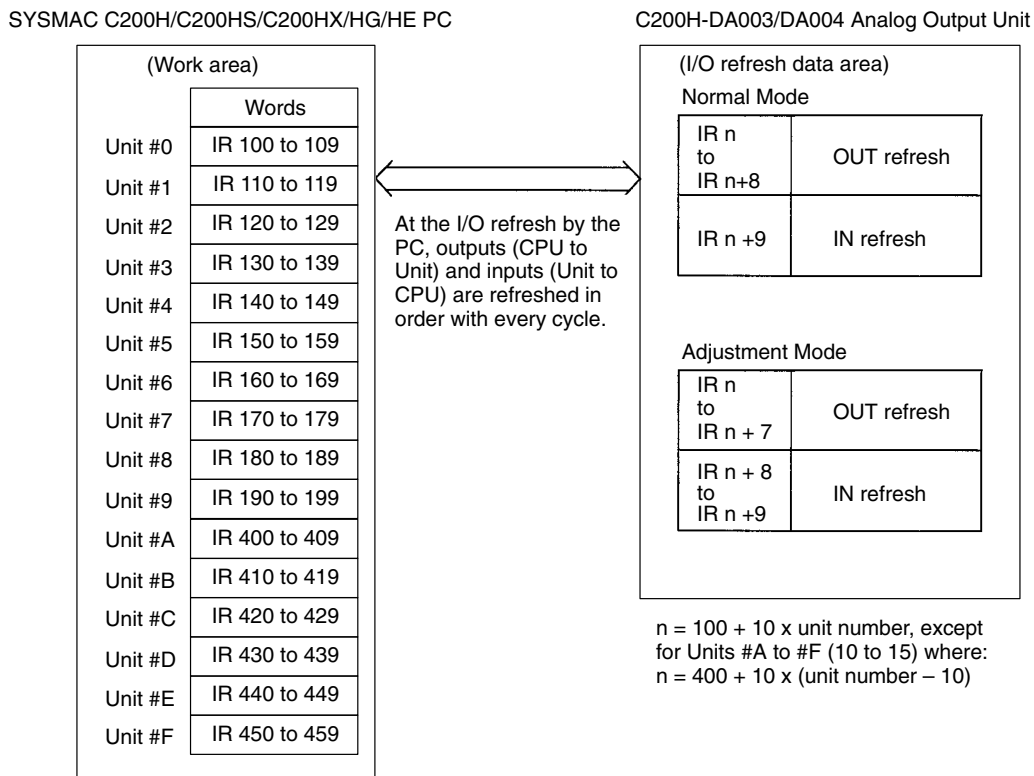

- Note**
- Switches A to F can be set for the C200HX/HG-CPU5□-E/6□-E. Setting numbers A to F for C200H, C200HS, C200HE, or C200HX/HG-CPU3□-E/4□-E PCs will cause an I/O UNIT OVER error and the Unit will not operate.
 - If two or more Special I/O Units are assigned the same unit number, an I/O UNIT OVER error will be generated and operation will stop.

Allocation for Normal Mode

For normal mode, set the operation mode switch on the rear panel of the Unit as shown in the following diagram.

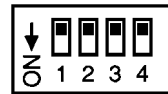

The allocation of IR words and bits is shown in the following table.

I/O	Word	Bits															
		15	14	13	12	11	10	9	8	7	6	5	4	3	2	1	0
Output (CPU to Unit)	n	Not used.								Conversion enable outputs							
										8	7	6	5	4	3	2	1
	n+1	Output 1 set value															
		16^3				16^2				16^1				16^0			
	n+2	Output 2 set value															
	n+3	Output 3 set value															
	n+4	Output 4 set value															
	n+5	Output 5 set value															
	n+6	Output 6 set value															
n+7	Output 7 set value																
n+8	Output 8 set value																
Input (Unit to CPU)	n+9	Error code								Output setting error outputs							
		16^1				16^0				8	7	6	5	4	3	2	1

Note For the IR word addresses, $n = 100 + 10 \times \text{unit number}$.
 For Units #A to #F (10 to 15), $n = 400 + 10 \times (\text{unit number} - 10)$.

Set Values and Stored Values

Item	Contents
Conversion enable	0: Stop conversion output 1: Begin conversion output
Set value	16-bit binary data
Output setting error	0: No error 1: Output setting error
Error code	Two digits, hexadecimal (00 for no error)

Allocation for Adjustment Mode

For adjustment mode, set the operation mode switch on the rear panel of the Unit as shown in the following diagram. When the Unit is set for adjustment mode, the RUN indicator on the front panel of the Unit will flash.

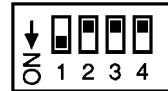

The allocation of IR words and bits is shown in the following table.

I/O	Word	Bits															
		15	14	13	12	11	10	9	8	7	6	5	4	3	2	1	0
Output (CPU to unit)	n	Not used.								Outputs to be adjusted							
										16 ¹				16 ⁰			
	n+1	Not used.								Not used.	Clr	Set	Up	Down	Gain	Off-set	
	n+2	Not used.															
	n+3	Not used.															
	n+4	Not used.															
	n+5	Not used.															
	n+6	Not used.															
Input (unit to CPU)	n+8	Conversion value for adjustment															
		16 ³				16 ²				16 ¹				16 ⁰			
	n+9	Error code								Not used.							
		16 ¹				16 ⁰											

Note For the IR word addresses, $n = 100 + 10 \times \text{unit number}$.
 For Units #A to #F (10 to 15), $n = 400 + 10 \times (\text{unit number} - 10)$.

Set Values and Stored Values

Item	Contents
Input to be adjusted	Sets input to be adjusted. Leftmost digit: Fixed at 2. Rightmost digit: 1 to 8
Offset (Offset Bit)	When ON, adjusts offset deviation.
Gain (Gain Bit)	When ON, adjusts gain deviation.
Down (Down Bit)	Decrements the adjustment value while ON.
Up (Up Bit)	Increments the adjustment value while ON.
Set (Set Bit)	Sets adjusted value and writes to EEPROM.
Clr (Clear Bit)	Clears adjusted value. (Returns to default status)
Conversion value for adjustment	The conversion value for adjustment is stored as 16 bits of binary data.
Error code	Two digits, hexadecimal (00 for no error)

3-4-2 DM Allocation and Contents

DM Allocation

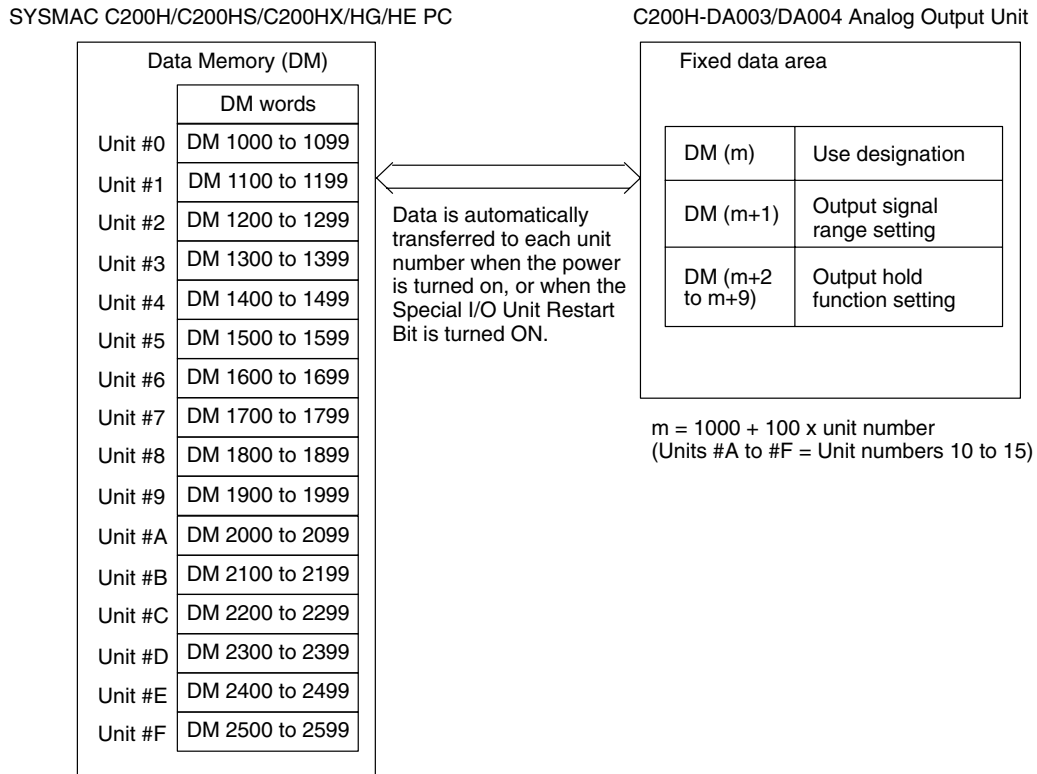

- Note**
- Switches A to F can be set for the C200HX/HG-CPU5□-E/6□-E. Setting numbers A to F for C200H, C200HS, C200HE, or C200HX/HG-CPU3□-E/4□-E PCs will cause an I/O UNIT OVER error and the Unit will not operate.
 - If two or more Special I/O Units are assigned the same unit number, an I/O UNIT OVER error will be generated and operation will stop.

DM Allocation Contents

The following table shows the allocation of DM words and bits for both normal and adjustment mode.

DM word	Bits															
	15	14	13	12	11	10	9	8	7	6	5	4	3	2	1	0
DM (m)	Not used.								Use designation outputs							
									8	7	6	5	4	3	2	1
DM (m+1)	Output signal range setting (See note 1.)															
	Output 8		Output 7		Output 6		Output 5		Output 4		Output 3		Output 2		Output 1	
DM (m+2)	Not used.								Output 1: Output status when conversion stopped							
DM (m+3)	Not used.								Output 2: Output status when conversion stopped							
DM (m+4)	Not used.								Output 3: Output status when conversion stopped							
DM (m+5)	Not used.								Output 4: Output status when conversion stopped							
DM (m+6)	Not used.								Output 5: Output status when conversion stopped							
DM (m+7)	Not used.								Output 6: Output status when conversion stopped							
DM (m+8)	Not used.								Output 7: Output status when conversion stopped							
DM (m+9)	Not used.								Output 8: Output status when conversion stopped							

- Note**
- This setting is not valid for the C200H-DA004 (current output model). The output signal range for the C200-DA004 is 4 to 20 mA, regardless of the settings.

- For the DM word addresses, $m = 1000 + 100 \times \text{unit number}$ (Units #A to #F = Unit numbers 10 to 15).

Set Values and Stored Values

Item	Contents
Use designation	0: Do not use. 1: Use.
Output signal range	00: -10 to 10 V 01: 0 to 10 V (See note.) 10: 1 to 5 V 11: Same as for setting "10" above.
Output status when stopped	00: CLR 0 output 01: HOLD Hold output prior to stop 02: MAX Output maximum value of range

Note This setting is not valid for the C200H-DA004 (current output model). The output signal range for the C200-DA004 is 4 to 20 mA, regardless of the settings.

3-5 Using the Functions

3-5-1 Setting Outputs and Signal Ranges

Output Numbers

The Analog Output Units only convert analog outputs specified by output numbers 1 to 8. In order to specify the analog outputs to be used, turn ON from a Peripheral Device the DM bits shown in the following diagram.

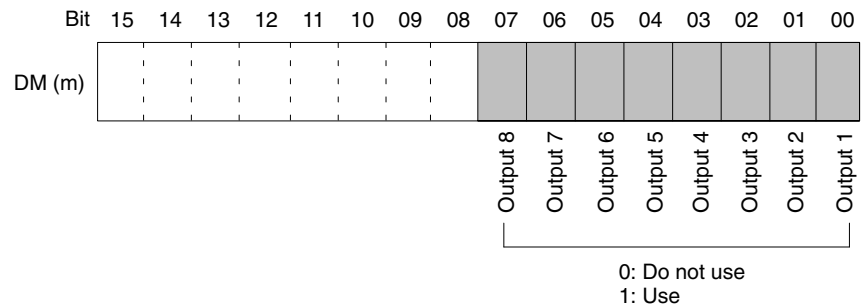

The analog output conversion cycle can be shortened by setting any unused output numbers to 0.

$$\text{Conversion cycle} = (1 \text{ ms}) \times (\text{Number of outputs used})$$

For the DM word addresses, $m = 1000 + 100 \times \text{unit number}$ (Units #A to #F = Unit numbers 10 to 15).

Output Signal Range

With the C200H-DA003 (voltage output model), any of three types of output signal range can be selected for each of the eight outputs (output numbers 1 to 8). In order to specify the output signal range for each output, set from a Peripheral Device the DM bits shown in the following diagram.

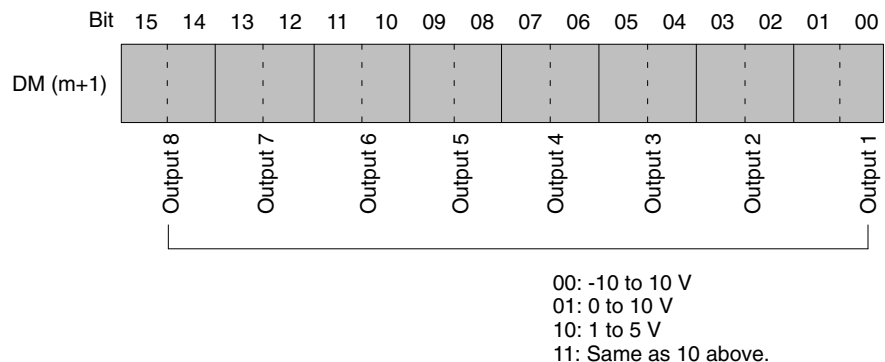

For the DM word addresses, $m = 1000 + 100 \times \text{unit number}$ (Units #A to #F = Unit numbers 10 to 15).

This setting is not valid for the C200H-DA004 (current output model). The output signal range for the C200-DA004 is 4 to 20 mA, regardless of the settings.

Note After making the DM settings from a Peripheral Device, it will be necessary to either power up the PC again or turn ON the Special I/O Unit Restart Bit in order to transfer the contents of the DM settings to the Special I/O Unit. For details regarding the Special I/O Unit Restart Bit, refer to 3-7-4 *Restarting Special I/O Units*.

3-5-2 Output Hold Function

The Analog Output Units stop conversion under the following circumstances, and output the value set by the output hold function.

- 1, 2, 3...**
1. When the Conversion Enable Bit is OFF. (Refer to 3-4-1 *IR Area Allocation*.)
 2. In adjustment mode, when something other than the output number is output during adjustment. (Refer to 3-6-1 *Adjustment Mode Operational Flow*.)
 3. When there is an output setting error. (Refer to 3-5-5 *Output Setting Errors*.)
 4. When a fatal error occurs at the PC. (Refer to the *C200HX/HG/HE Programming Manual*.)

CLR, HOLD, or MAX can be selected for the output status when conversion is stopped.

Output signal range	CLR	HOLD	MAX
0 to 10 V	-0.5 V (Min.-5% of full scale)	Voltage that was output just prior to stop.	10.5 V (Max.+5% of full scale)
-10 to 10 V	0.0 V	Voltage that was output just prior to stop.	11.0 V (Max.+5% of full scale)
1 to 5 V	0.8 V (Min.-5% of full scale)	Voltage that was output just prior to stop.	5.2 V (Max.+5% of full scale)
4 to 20 mA	3.2 mA (Min.-5% of full scale)	Current that was output just prior to stop.	20.8 mA (Max.+5% of full scale)

In order to specify the the output hold function, set from a Peripheral Device the DM words shown in the following table.

DM word	Function	Set value
DM (m+2)	Output 1: Output status when stopped	xx00: CLR 0 output
DM (m+3)	Output 2: Output status when stopped	
DM (m+4)	Output 3: Output status when stopped	xx01: HOLD Hold output value prior to stop
DM (m+5)	Output 4: Output status when stopped	
DM (m+6)	Output 5: Output status when stopped	xx02: MAX Output maximum value of range
DM (m+7)	Output 6: Output status when stopped	
DM (m+8)	Output 7: Output status when stopped	Set any value in the leftmost bytes (xx).
DM (m+9)	Output 8: Output status when stopped	

For the DM word addresses, $m = 1000 + 100 \times \text{unit number}$ (Units #A to #F = Unit numbers 10 to 15).

Note After making the DM settings from a Peripheral Device, it will be necessary to either power up the PC again or turn ON the Special I/O Unit Restart Bit in order to transfer the contents of the DM settings to the Special I/O Unit. For details regarding the Special I/O Unit Restart Bit, refer to 3-7-4 *Restarting Special I/O Units*.

3-5-3 Writing Set Values

Analog output set values are written to IR words n+1 through n+8.

Word	Function	Stored value
n+1	Output 1 set value	16-bit binary data
n+2	Output 2 set value	
n+3	Output 3 set value	
n+4	Output 4 set value	
n+5	Output 5 set value	
n+6	Output 6 set value	
n+7	Output 7 set value	
n+8	Output 8 set value	

For the IR word addresses, $n = 100 + 10 \times \text{unit number}$.

For Units #A to #F (10 to 15), $n = 400 + 10 \times (\text{unit number} - 10)$.

Use MOV(21) or XFER(70) to write values in the user program.

Example 1

In this example, the set value from only one input is read. (The unit number is #0.)

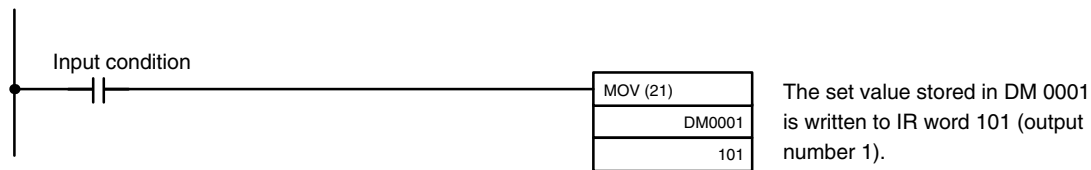

Example 2

In this example, multiple set values are written. (The unit number is #0.)

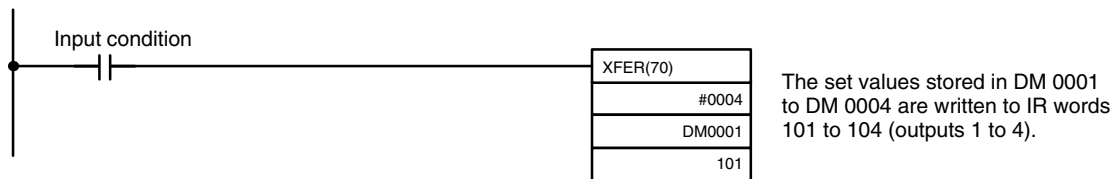

For details regarding set value scaling, refer to page 118, *Sample Program 5: Scaling Function*.

Note Turn ON the Conversion Enable Bit for converting set values into analog output.

3-5-4 Starting and Stopping Conversion

To begin analog output conversion, turn ON the corresponding Conversion Enable Bit (word n, bits 00 to 07) from the user's program.

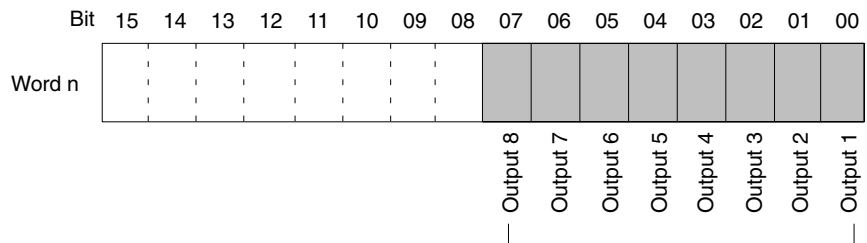

Analog conversion is executed while these bits are ON. When the bits are turned OFF, the conversion is stopped and the output data is held. (Refer to 3-5-2 Output Hold Function.)

For the IR word addresses, $n = 100 + 10 \times \text{unit number}$.

For Units #A to #F (10 to 15), $n = 400 + 10 \times (\text{unit number} - 10)$.

The analog output when conversion is stopped will differ depending on the output signal range setting. (Refer to 3-5-1 *Setting Outputs and Signal Ranges*.) Conversion will not begin under the following conditions even if the Conversion Enable Bit is turned ON.

- 1, 2, 3...
1. In adjustment mode, when something other than the output number is output during adjustment. (Refer to 3-6-1 *Adjustment Mode Operational Flow*.)
 2. When there is an output setting error. (Refer to 3-5-5 *Output Setting Errors*.)
 3. When a fatal error occurs at the PC. (Refer to the *C200HX/HG/HE Programming Manual*.)

In this example, conversion is begun for analog output number 1. (The unit number is #0.)



3-5-5 Output Setting Errors

If the analog output set value is outside of the range, a setting error signal will be stored in IR word n+9 (bits 00 to 07). To use disconnection detection with the user's program, set these bits as execution conditions in the ladder program.

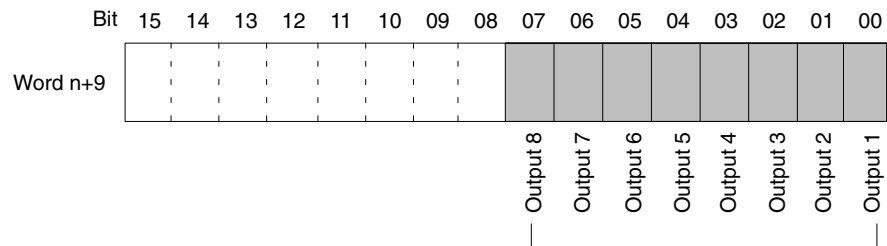

When a setting error is detected for a particular output, the corresponding bit turns ON. When the error is cleared, the bit turns OFF.

For the IR word addresses, $n = 100 + 10 \times \text{unit number}$.

For Units #A to #F (10 to 15), $n = 400 + 10 \times (\text{unit number} - 10)$.

The voltage or current for an output number at which an output setting error has occurred will be output according to the output hold function.

3-6 Offset and Gain Adjustment

This function is designed to calibrate outputs depending on devices to be connected.

3-6-1 Adjustment Mode Operational Flow

The following diagram shows the flow of operations when using the adjustment mode for adjusting offset and gain.

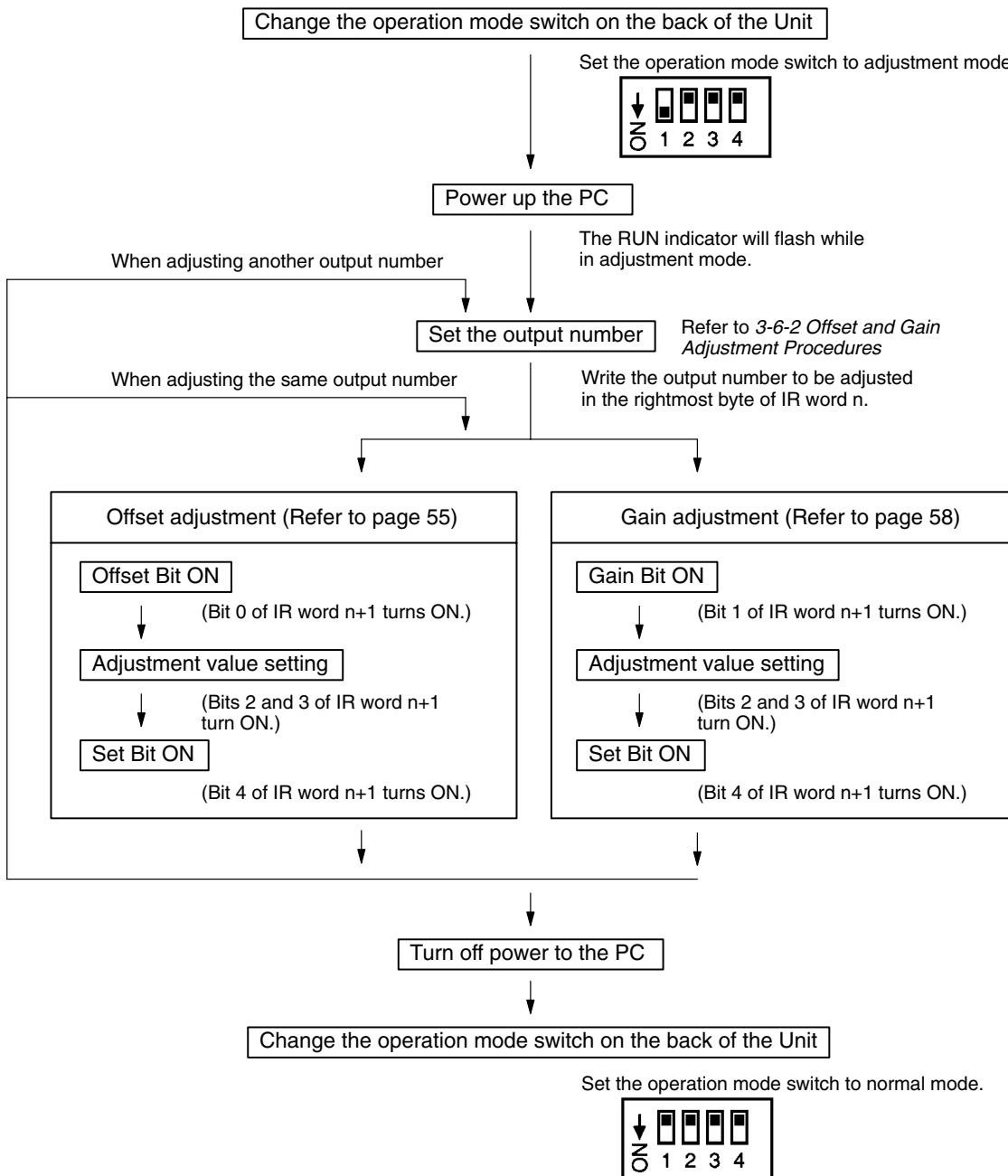

Caution Be sure to turn off the power to the PC before changing the operation mode switch settings. If the I/O table is registered in the PC, an I/O setting error may occur, not allowing any adjustment. In such a case, either cancel the I/O table or create the I/O table again. When making adjustments, be sure to perform both the offset adjustment and gain adjustment.

3-6-2 Offset and Gain Adjustment Procedures

Specifying Output Number to be Adjusted

To specify the output number to be adjusted, write the value to the rightmost byte of IR word n as shown in the following diagram.

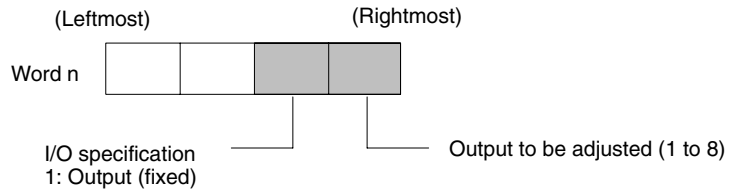

For the IR word addresses, $n = 100 + 10 \times \text{unit number}$.

For Units #A to #F (10 to 15), $n = 400 + 10 \times (\text{unit number} - 10)$.

The following example uses output number 1 adjustment for illustration. (The unit number is 0.)

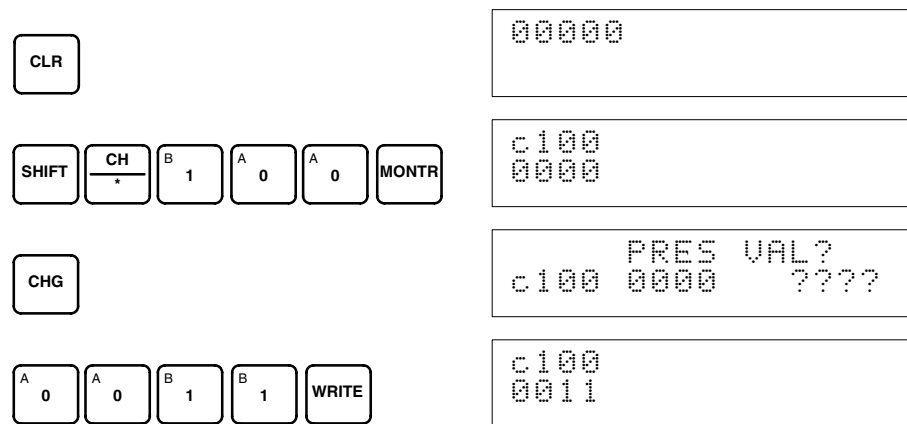

Bits Used for Adjusting Offset and Gain

The IR word n+1 bits shown in the following diagram are used for adjusting offset and gain.

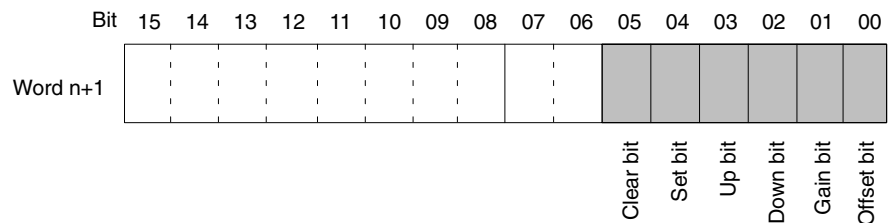

Offset Adjustment

The procedure for adjusting the analog output offset is explained below. As shown in the following diagram, the set value is adjusted so that the analog output reaches the standard value (0V/1V/4mA).

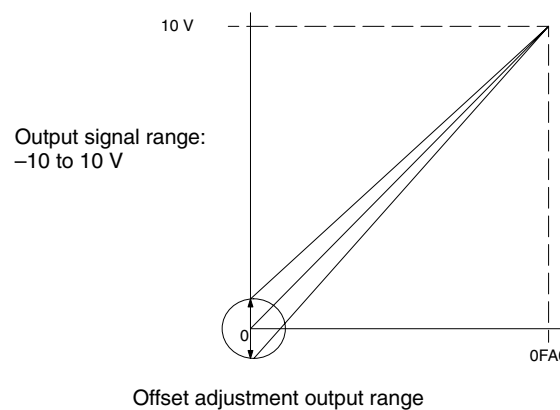

The following example uses output number 1 adjustment for illustration. (The unit number is 0.)

- 1, 2, 3... 1. Turn ON bit 00 (the Offset Bit) of IR word n+1. (Hold the ON status.)

CLR 000000

SHIFT CONT # B 1 A 0 B 1 A 0 A 0 MONTR

10100
^OFF

PLAY SET 10100
■ ON

2. Check whether the output devices are connected.

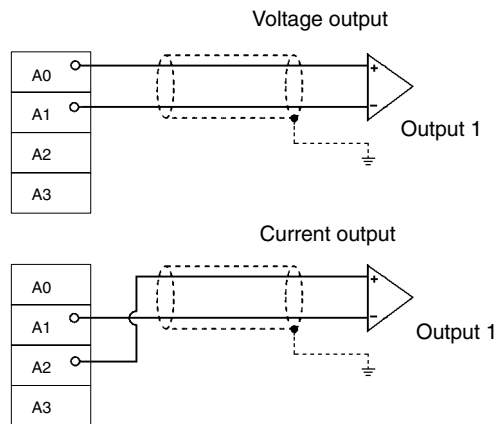

3. Monitor IR word n+8 and check the set value while the Offset Bit is ON.

CLR 000000

SHIFT CH * B 1 A 0 8 MONTR

c100
0000

4. Change the set value so that the output voltage and output current are as shown in the following table. The data can be set within the indicated ranges.

Output signal range	Output voltage/current	Output range
0 to 10 V	0 V	FF38 to 00C8
-10 to 10 V	0 V	
1 to 5 V	1 V	
4 to 20 mA	4 mA	

Change the set value, using the Up Bit (bit 03 of word n+1) and the Down Bit (bit 02 of word n+1).

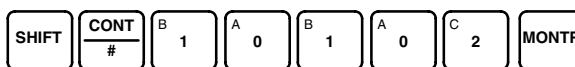
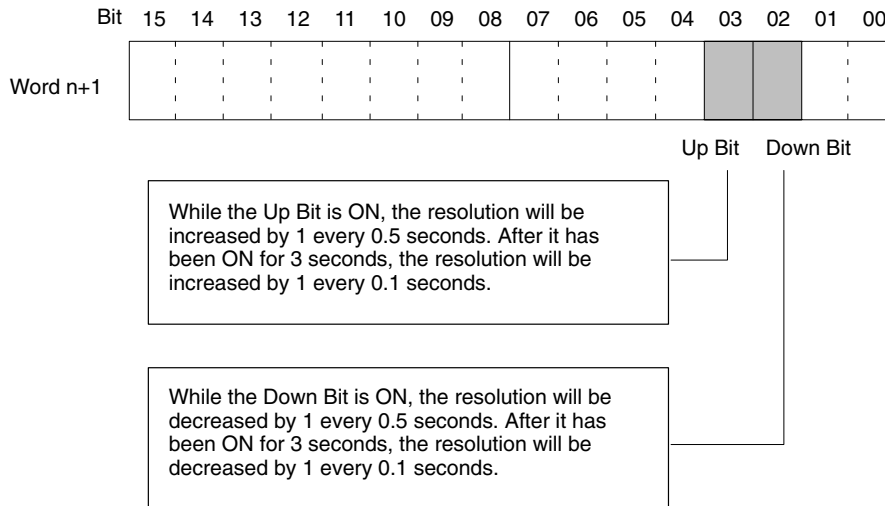

```
10102 c100
^OFF 0000
```

The bit will remain ON until the output becomes an appropriate value, at which time, it will turn OFF.



```
10102 c100
■ ON FFFF
```



```
10102 c100
■ OFF FFFF
```

5. Check the 0V/1V/4mA output, and then turn bit 04 (the Set Bit) of IR word n+1 OFF, ON, and then OFF again.



```
10104 10102 c100
^OFF ^ OFF FFFF
```



```
10104 10102 c100
■ ON ^ OFF FFFF
```



```
10104 10102 c100
■ OFF ^ OFF FFFF
```

While the Offset Bit is ON, the offset value will be saved to the Unit's EEPROM when the Set Bit turns ON.

6. To finish the offset adjustment, turn OFF bit 00 (the Offset Bit) of IR word n+1.



```
10100 10104
^ ON ^OFF
```



```
10100 10104
■ OFF ^OFF
```

Caution Do not turn OFF the power supply or restart the Unit while the Set Bit is ON (data is being written to the EEPROM). Otherwise, illegal data may be written in the Unit's EEPROM and "Special I/O Unit Errors" may occur when the power supply is turned ON or when the Unit is restarted, causing a malfunction. When making adjustments, be sure to perform both the offset adjustment and gain adjustment.

Note The EEPROM can be overwritten 50,000 times.

Gain Adjustment

The procedure for adjusting the analog output gain is explained below. As shown in the following diagram, the set value is adjusted so that the analog output is maximized (to 10V/5V/20mA).

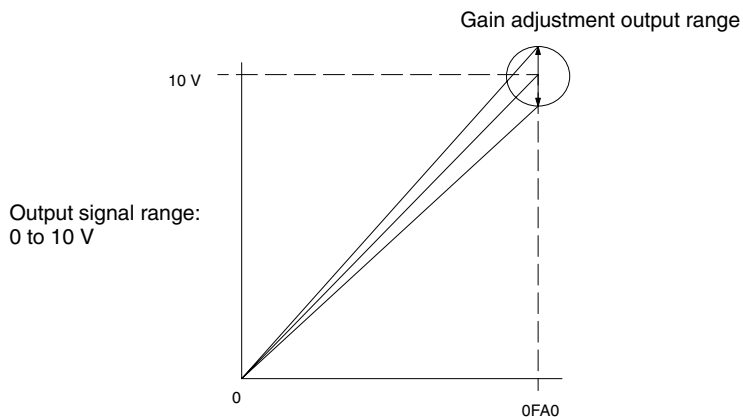

The following example uses output number 1 adjustment for illustration. (The unit number is 0.)

- 1, 2, 3...** 1. Turn ON bit 01 (the Gain Bit) of IR word n+1. (Hold the ON status.)



```
10101
^OFF
```



```
10101
■ ON
```

2. Check whether the output devices are connected.

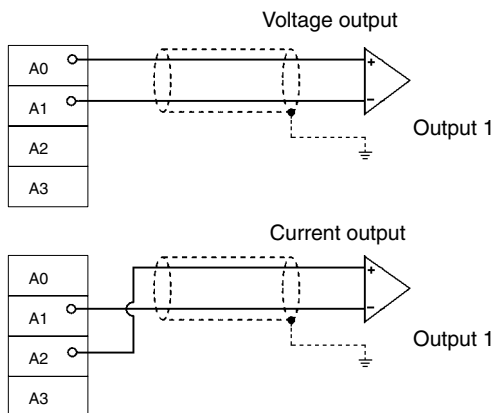

3. Monitor IR word n+8 and check the set value while the Gain Bit is ON.

CLR 00000

SHIFT CH B 1 A 0 8 MONTR

c108
0FA0

4. Change the set value so that the output voltage and output current are as shown in the following table. The data can be set within the indicated ranges.

Output signal range	Output voltage/current	Output range
0 to 10 V	10 V	0ED8 to 1068
-10 to 10 V	10 V	0708 to 0898
1 to 5 V	5 V	0ED8 to 1068
4 to 20 mA	20 mA	0ED8 to 1068

Change the set value, using the Up Bit (bit 03 of word n+1) and the Down Bit (bit 02 of word n+1).

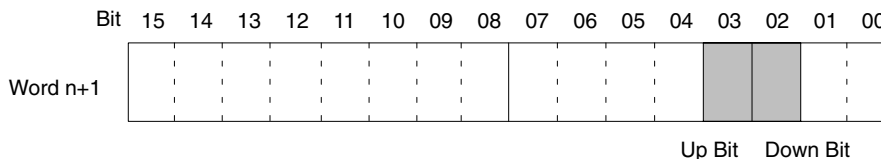

While the Up Bit is ON, the resolution will be increased by 1 every 0.5 seconds. After it has been ON for 3 seconds, the resolution will be increased by 1 every 0.1 seconds.

While the Down Bit is ON, the resolution will be decreased by 1 every 0.5 seconds. After it has been ON for 3 seconds, the resolution will be decreased by 1 every 0.1 seconds.



```
10102 c108
^OFF 0FA0
```

The bit will remain ON until the output becomes an appropriate value, at which time, it will turn OFF.



```
10102 c108
█ ON 0F9F
```



```
10102 c108
█ OFF 0F9F
```

5. Check the 10V/5V/20mA output, and then turn bit 04 (the Set Bit) of IR word n+1 OFF, ON, and then OFF again.



```
10104 10102 c108
^OFF ^ OFF 0F9F
```



```
10104 10102 c108
█ ON ^ OFF 0F9F
```



```
10104 10102 c108
█ OFF ^ OFF 0F9F
```

While the Gain Bit is ON, the gain value will be saved to the Unit's EEPROM when the Set Bit turns ON.

6. To finish the gain adjustment, turn OFF bit 01 (the Gain Bit) of IR word n+1.



```
10101 10104
^OFF ^OFF
```



```
10101 10104
█ OFF ^OFF
```

Caution Do not turn OFF the power supply or restart the Unit while the Set Bit is ON (data is being written to the EEPROM). Otherwise, illegal data may be written in the Unit's EEPROM and "Special I/O Unit Errors" may occur when the power supply is turned ON or when the Unit is restarted, causing a malfunction. When making adjustments, be sure to perform both the offset adjustment and gain adjustment.

Note The EEPROM can be overwritten 50,000 times.

Clearing Offset and Gain Adjusted Values

Follow the procedure outlined below to return the offset and gain adjusted values to their default settings.

The following example uses output number 1 adjustment for illustration. (The unit number is 0.)

- 1, 2, 3... 1. Turn ON bit 05 (the Clear Bit) of IR word n+1. (Hold the ON status.) Regardless of the set value, 0000 will be monitored in IR word n+8.



```
10105
^OFF
```



```
10105
■ ON
```

2. Turn bit 04 of IR word n+1 ON and then OFF again.



```
10104 10105
^OFF ^ ON
```



```
10104 10105
■ ON ^ ON
```



```
10104 10105
■ OFF ^ ON
```

While the Clear Bit is ON, the default offset and gain values will be saved to the Unit's EEPROM when the Set Bit turns ON.

3. To finish the clearing of adjusted values, turn OFF bit 05 (the Clear Bit) of IR word n+1.



```
10105 10104
^ ON ^OFF
```



```
10105 10104
■ OFF ^OFF
```

Caution Do not turn OFF the power supply or restart the Unit while the Set Bit is ON (data is being written to the EEPROM). Otherwise, illegal data may be written in the Unit's EEPROM and "Special I/O Unit Errors" may occur when the power supply is turned ON or when the Unit is restarted, causing a malfunction.

Note The EEPROM can be overwritten 50,000 times.

3-7 Error Processing

3-7-1 Troubleshooting Procedure

Use the following procedure for troubleshooting Analog Input Unit errors.

- 1, 2, 3... 1. Error occurs.
2. Is the ERROR indicator lit?
 - Yes: Error detected by Analog Output Unit
(Refer to 3-7-2 Errors Detected by Analog Output Unit.)
 - No: Go to the next step.
3. Is the RUN indicator lit?
 - Yes: Error detected by CPU Unit
(Refer to 3-7-3 Errors Detected by CPU Unit.)
Check whether the operation mode switch on the back of the Analog Output Unit is set correctly.
 - No: Refer to 3-7-5 Troubleshooting.

If both the ERROR and RUN indicators are lit, check whether the operation mode switch on the back of the Analog Output Unit is set correctly.

3-7-2 Errors Detected by Analog Output Unit

When an error occurs at the Analog Output Unit, the ERROR indicator on the front panel of the Unit lights and the error code is stored in bits 08 to 15 of IR word n+9.

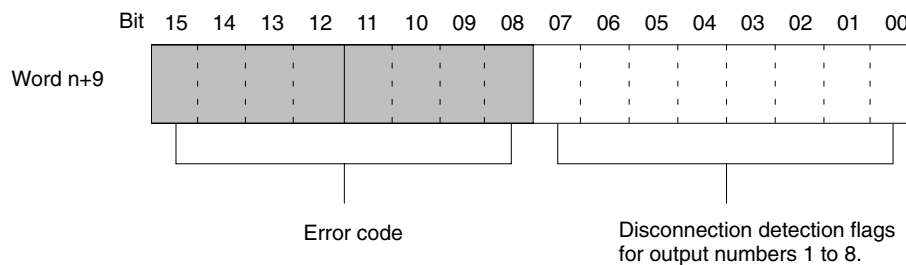

For the IR word addresses, $n = 100 + 10 \times \text{unit number}$.
 For Units #A to #F (10 to 15), $n = 400 + 10 \times (\text{unit number} - 10)$.

Error code		Error contents	Countermeasure
8	1	In adjustment mode, adjustment cannot be performed because the specified input number is not set for use or because the wrong input number is specified.	Check whether the word n input number to be adjusted is set from 11 to 18. Check whether the input number to be adjusted is set for use by means of the DM setting.
8	3	The output setting range has been exceeded.	Correct the set value.
8	8	An EEPROM writing error has occurred while in adjustment mode.	Turn the Set Bit OFF, ON, and OFF again. If the error persists even after the reset, replace the Analog Output Unit.
F	2	The wrong output status for when conversion is stopped has been specified.	Specify a number from 0000 to 0002.

Note Errors indicated with 8□ codes are automatically reset when proper countermeasures are taken. The errors indicated with F□ codes are cleared when the power is turned on after making the correct settings and when the Special I/O Unit Restart Bit is turned OFF, ON, and OFF again.

3-7-3 Errors Detected by CPU Unit

When the CPU Unit detects an error at a Special I/O Unit, it outputs to the CPU's SR and AR areas as shown below.

Special I/O Unit Error Flag

Bit	Error	Contents	CPU Unit status	LED indicators
25415	I/O UNIT OVER	The same unit number has been set for more than one Special I/O Unit.	CPU Unit operation is stopped.	RUN: Not lit ERROR: Not lit
	SPECIAL I/O UNIT ERROR	Error occurred in I/O refresh between Special I/O Unit and CPU Unit.	Operation is stopped only for faulty Unit.	RUN: Not lit ERROR: Not lit

Special I/O Unit Error Flags

Bits		Functions	
C200HX/HG/HE			
	C200H/HS		
28200	AR 0000	Unit #0 Error Flag	Turns ON for any unit number when I/O UNIT OVER or SPECIAL I/O UNIT ERROR occurs.
28201	AR 0001	Unit #1 Error Flag	
28202	AR 0002	Unit #2 Error Flag	
28203	AR 0003	Unit #3 Error Flag	
28204	AR 0004	Unit #4 Error Flag	
28205	AR 0005	Unit #5 Error Flag	
28206	AR 0006	Unit #6 Error Flag	
28207	AR 0007	Unit #7 Error Flag	
28208	AR 0008	Unit #8 Error Flag	
28209	AR 0009	Unit #9 Error Flag	
28210 (See note.)	---	Unit #A Error Flag	
28211 (See note.)	---	Unit #B Error Flag	
28212 (See note.)	---	Unit #C Error Flag	
28213 (See note.)	---	Unit #D Error Flag	
28214 (See note.)	---	Unit #E Error Flag	
28215 (See note.)	---	Unit #F Error Flag	

Note SR bits 28210 to 28215 cannot be used with C200HE, C200HX/HG-CPU3□-E/4□-E PCs.

3-7-4 Restarting Special I/O Units

There are two ways to restart Special I/O Unit operation after having changed DM contents or having corrected the cause of an error. The first way is to power up the PC again, and the second way is to turn the Special I/O Unit Restart Bit ON and then OFF again.

Special I/O Unit Restart Bits

Bits		Functions	
C200HX/HG/HE			
	C200H/HS		
28100	AR 0100	Unit #0 Restart Bit	Turning the Restart Bit for any Unit ON and then OFF again restarts that Unit.
28101	AR 0101	Unit #1 Restart Bit	
28102	AR 0102	Unit #2 Restart Bit	
28103	AR 0103	Unit #3 Restart Bit	
28104	AR 0104	Unit #4 Restart Bit	
28105	AR 0105	Unit #5 Restart Bit	
28106	AR 0106	Unit #6 Restart Bit	
28107	AR 0107	Unit #7 Restart Bit	
28108	AR 0108	Unit #8 Restart Bit	
28109	AR 0109	Unit #9 Restart Bit	
28110 (See note.)	---	Unit #A Restart Bit	
28111 (See note.)	---	Unit #B Restart Bit	
28112 (See note.)	---	Unit #C Restart Bit	
28113 (See note.)	---	Unit #D Restart Bit	
28114 (See note.)	---	Unit #E Restart Bit	
28115 (See note.)	---	Unit #F Restart Bit	

Note SR bits 28110 to 28115 cannot be used with C200HE, C200HX/HG-CPU3□-E/4□-E PCs.

If the error is not cleared even after turning the Special I/O Unit Restart Bit ON and then OFF again, then replace the Unit.

3-7-5 Troubleshooting

The following tables explain the probable causes of troubles that may occur, and the countermeasures for dealing with them.

Analog Output Does Not Change

Probable Cause	Countermeasure	Page
The output is not set for being used.	Set the output for being used.	50
The output hold function is in operation.	Turn ON the Output Conversion Enable Bit.	52
The conversion value is set outside of the permissible range.	Set the data within the range.	39

Output Does Not Change as Intended

Probable Cause	Countermeasure	Page
The output signal range setting is wrong.	Correct the output signal range setting.	50
The I/O specifications of the output device do not match those of the Analog Output Unit (e.g., input signal range, input impedance).	Change the output device.	38
The offset or gain is not adjusted.	Adjust the offset or gain.	54

Outputs are Inconsistent

Probable Cause	Countermeasure	Page
The output signals are being affected by external noise.	Try changing the shielded cable connection (e.g., the grounding at the output device).	44

SECTION 4

C200H-MAD01 Analog I/O Unit

This section provides the information required to install and operate a C200H-MAD01 Analog I/O Unit.

4-1	Specifications	66
4-1-1	General Specifications	66
4-1-2	Performance Specifications	66
4-1-3	Input Specifications	67
4-1-4	Output Specifications	68
4-2	Nomenclature and Functions	70
4-2-1	Indicators	70
4-2-2	Unit Number Switch	71
4-2-3	Operation Mode Switch	71
4-3	Wiring	72
4-3-1	Terminal Arrangement	72
4-3-2	Internal Circuitry	72
4-3-3	Line Breakage while Using Voltage Input	73
4-3-4	I/O Wiring Example	74
4-3-5	I/O Wiring Considerations	75
4-4	IR and DM Areas	76
4-4-1	IR Area Allocation and Contents	76
4-4-2	DM Allocation and Contents	79
4-5	Analog Input Functions	81
4-5-1	Setting Inputs and Signal Ranges	81
4-5-2	Reading Conversion Values	82
4-5-3	Mean Value Processing	82
4-5-4	Peak Value Function	84
4-5-5	Input Disconnection Detection Function	85
4-6	Analog Output Functions	86
4-6-1	Setting Outputs and Signal Ranges	86
4-6-2	Output Hold Function	87
4-6-3	Writing Set Values	87
4-6-4	Starting and Stopping Conversion	88
4-6-5	Output Setting Errors	89
4-7	Ratio Conversion Function	89
4-8	Offset and Gain Adjustment	92
4-8-1	Adjustment Mode Operational Flow	92
4-8-2	Input Offset and Gain Adjustment Procedures	93
4-8-3	Output Offset and Gain Adjustment Procedures	98
4-9	Error Processing	105
4-9-1	Troubleshooting Procedure	105
4-9-2	Errors Detected by Analog I/O Unit	106
4-9-3	Errors Detected by CPU Unit	107
4-9-4	Restarting Special I/O Units	108
4-9-5	Troubleshooting	108

4-1 Specifications

4-1-1 General Specifications

All general specifications of the C200H-MAD01 Analog I/O Unit conform to those of the C200H, C200HS, and C200HX/HG/HE Series.

4-1-2 Performance Specifications

Item		C200H-MAD01		
		Voltage I/O	Current I/O	
Input	Number of analog inputs	2		
	Input signal range (note 1)	0 to 10 V -10 to 10 V 1 to 5 V	4 to 20 mA	
	Max. input signal (note 2)	±15 V	±30 mA	
	Input impedance	1 MΩ min.	250 Ω (rated value)	
	Resolution	1/4000 (full scale)		
	Converted output data	16-bit binary data		
	Accuracy (note 3)	23°±2°C	±0.2% of full scale	±0.4% of full scale
		0° to 55°C	±0.4% of full scale	±0.6% of full scale
Output	Number of analog outputs	2		
	Output signal range (note 1)	0 to 10 V -10 to 10 V 1 to 5 V	4 to 20 mA	
	Output impedance	0.5 Ω max.	---	
	Max. output current	12 mA	---	
	Max. load resistance	---	600 Ω max. (note 5)	
	Resolution	1/4000 (full scale)		
	Set data	16-bit binary data		
	Accuracy (note 3)	23°±2°C	±0.3% of full scale	±0.5% of full scale
0° to 55°C		±0.5% of full scale	±0.8% of full scale	
Common	Conversion time (note 4)	1.0 ms/point max.		
	Isolation	Between I/O terminals and PC: photocoupler (No isolation between individual input and output signals.)		
	External connectors	28-point terminal block (M3 screws)		
	Power consumption	100 mA max. at 5 VDC 200 mA max. at 26 VDC		
	Dimensions	34.5 x 130 x 128 (W x H x D) mm (refer to <i>Appendix A Dimensions</i>)		
	Weight	450 g max.		

- Note**
1. The I/O signal range can be set individually for each input.
 2. Operate within the ranges listed above. Operation in ranges beyond the maximum input signals will damage the Unit.
 3. The accuracy is given for full scale. For example, an accuracy of ±0.2% means a maximum error of ±8 (BCD).
The default setting is adjusted with the voltage input for the analog input and with the current output for the analog output. When using the current input and voltage output, perform the offset and gain adjustment as required.

4. A/D conversion time is the time it takes for an analog signal to be stored in memory as converted data after it has been input. It takes at least one cycle before the converted data is read by the CPU Unit. D/A conversion time is the time required for converting and outputting the PC data. It takes at least one cycle for the data stored in the PC to be read by the Analog Output Unit. By executing an I/O refresh, the conversion time may be extended by an additional 0.3 ms approximately.
5. The default setting is for current output (load resistance: 250 Ω). When using voltage output, or when using current output with a load resistance other than 250 Ω, perform the offset and gain adjustment as required.

4-1-3 Input Specifications

Range: 1 to 5 V (4 to 20 mA)

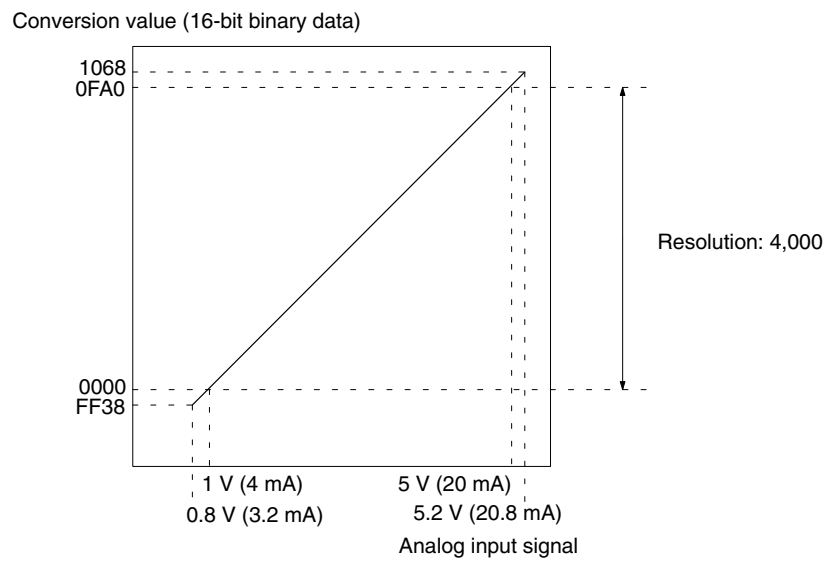

Range: 0 to 10 V

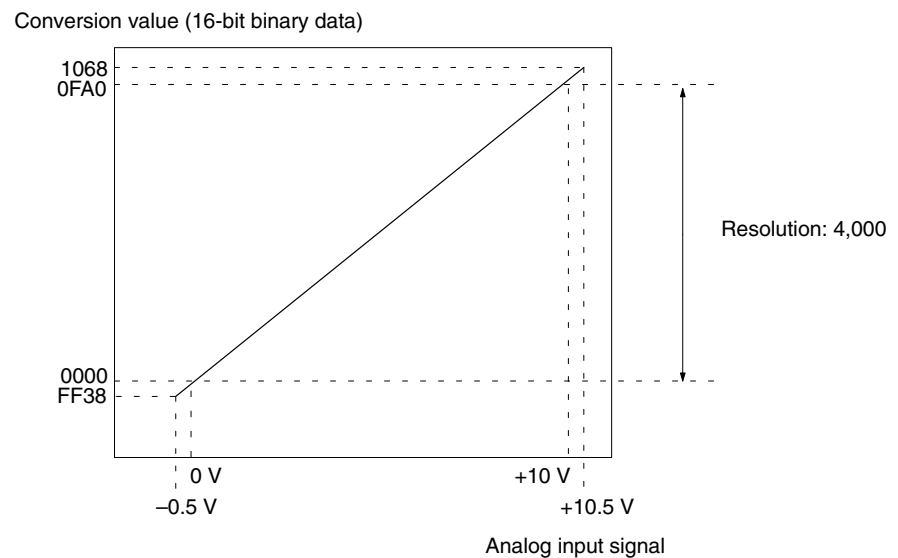

Range: -10 to 10 V

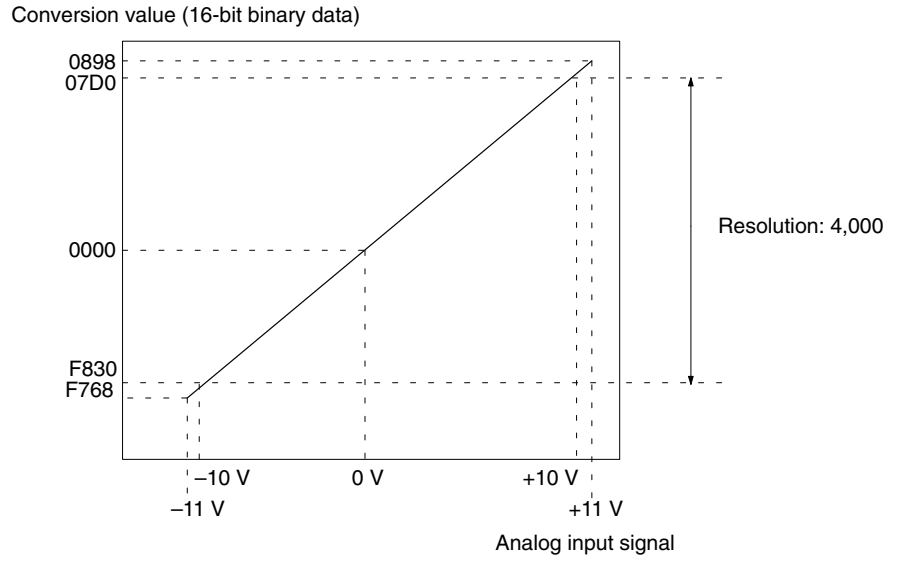

4-1-4 Output Specifications

Range: 1 to 5 V (4 to 20 mA)

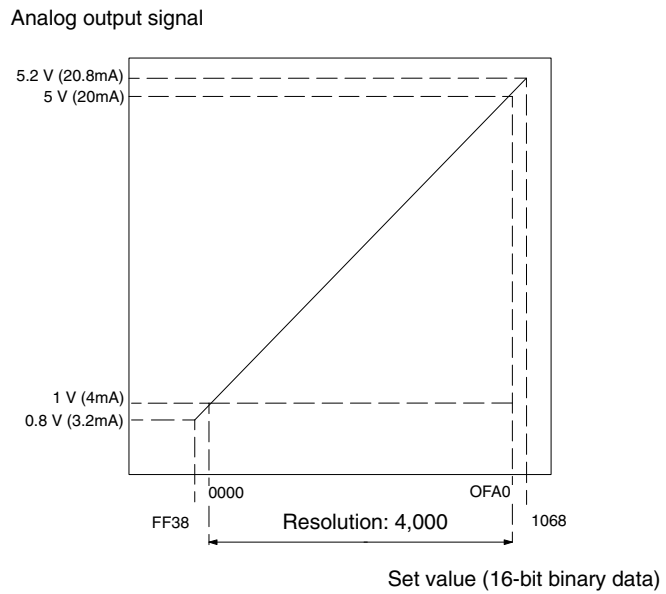

Range: 0 to 10 V

Analog output signal

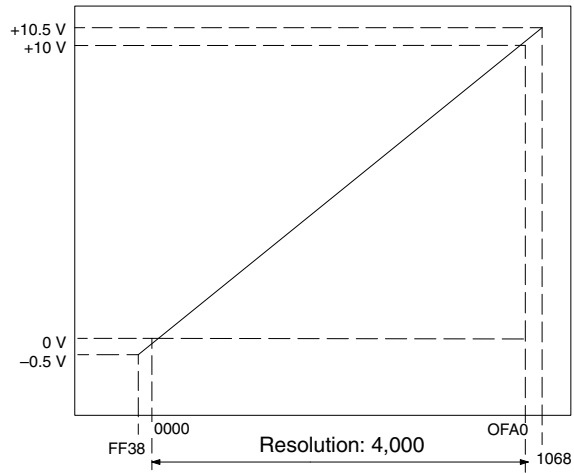

Set value (16-bit binary data)

Range: -10 to 10 V

Analog output signal

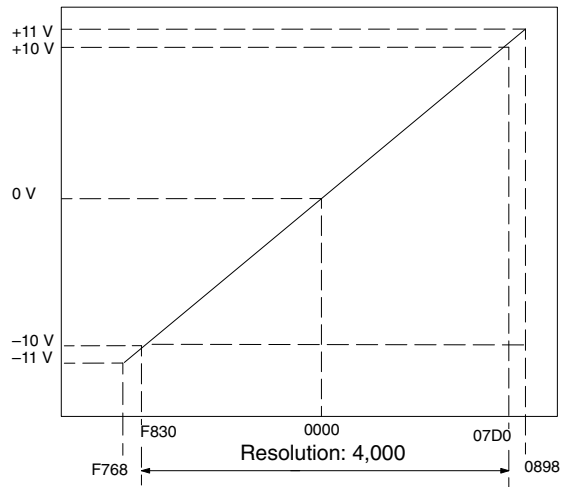

Set value (16-bit binary data)

4-2 Nomenclature and Functions

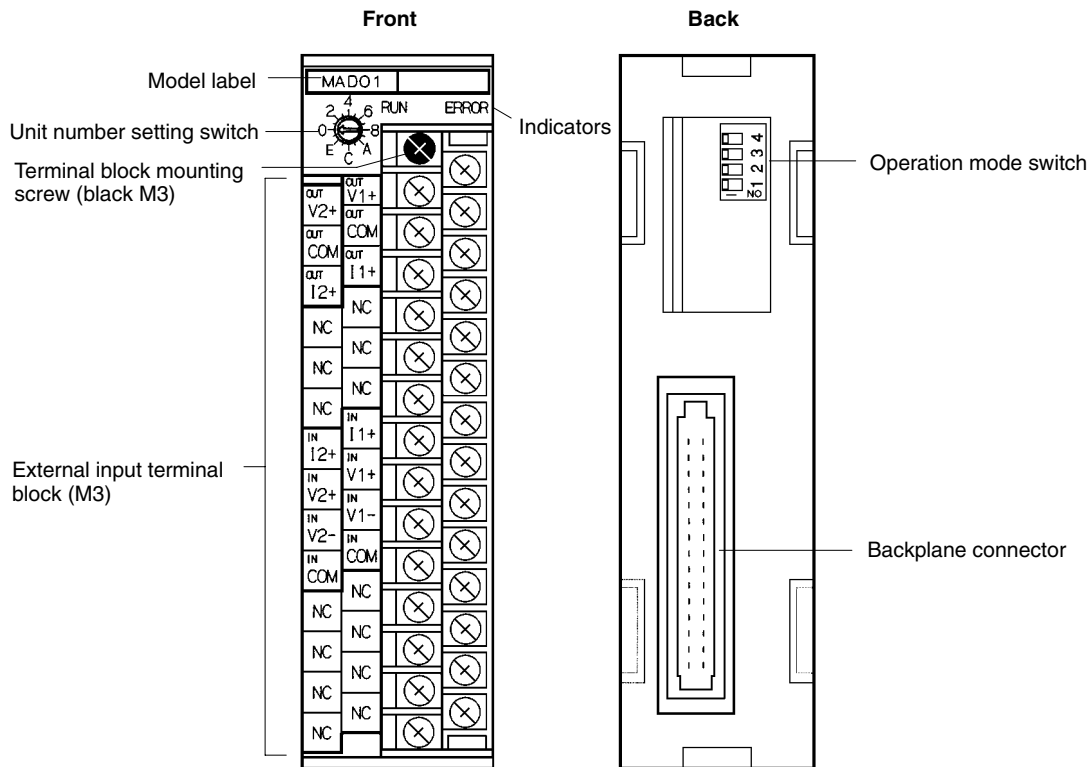

The terminal block is attached by a connector. It can be removed by loosening the black mounting screw. When removing the terminal block after wiring, remove the wire connected to the top terminal of the right column.

Check to be sure that the black terminal block mounting screw is securely tightened to a torque of 0.5 N • m.

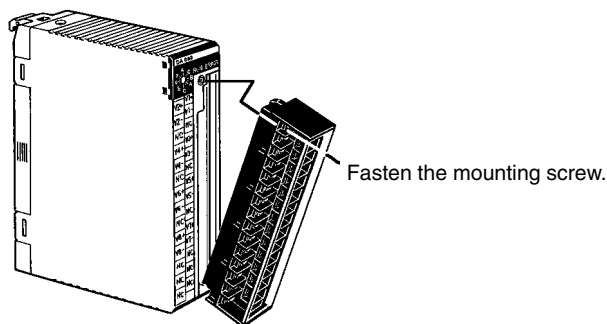

4-2-1 Indicators

The RUN and ERROR indicators show the operating status of the Unit. The following table shows the meanings of the indicators.

LED	Indicator	Operating status
RUN (green)	Lit	Operating in normal mode.
	Flashes	Operating in adjustment mode.
	Not lit	Abnormal (Unit operation stopped)
ERROR (red)	Lit	Error occurred. The error codes are stored in bits 08 to 15 of word n+9.
	Not lit	Other than the above.

4-2-2 Unit Number Switch

The CPU Unit and Analog I/O Unit exchange data via the IR area and the DM area. The IR and DM word addresses that each Analog Input Unit occupies are set by the unit number switch on the front panel of the Unit.

Always turn off the power before setting the unit number. Use a flat-blade screwdriver, being careful not to damage the slot in the screw. Be sure not to leave the switch midway between settings.

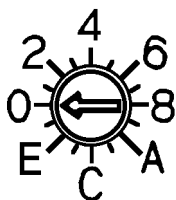

Switch setting	Unit number	IR words	DM words
0	Unit #0	IR 100 to 109	DM 1000 to 1099
1	Unit #1	IR 110 to 119	DM 1100 to 1199
2	Unit #2	IR 120 to 129	DM 1200 to 1299
3	Unit #3	IR 130 to 139	DM 1300 to 1399
4	Unit #4	IR 140 to 149	DM 1400 to 1499
5	Unit #5	IR 150 to 159	DM 1500 to 1599
6	Unit #6	IR 160 to 169	DM 1600 to 1699
7	Unit #7	IR 170 to 179	DM 1700 to 1799
8	Unit #8	IR 180 to 189	DM 1800 to 1899
9	Unit #9	IR 190 to 199	DM 1900 to 1999
A	Unit #A	IR 400 to 409	DM 2000 to 2099
B	Unit #B	IR 410 to 419	DM 2100 to 2199
C	Unit #C	IR 420 to 429	DM 2200 to 2299
D	Unit #D	IR 430 to 439	DM 2300 to 2399
E	Unit #E	IR 440 to 449	DM 2400 to 2499
F	Unit #F	IR 450 to 459	DM 2500 to 2599

- Note**
- Switches A to F can be set for the C200HX/HG-CPU5□-E/6□-E. Setting numbers A to F for C200H, C200HS, C200HE, or C200HX/HG-CPU3□-E/4□-E PCs will cause an I/O UNIT OVER error and the Unit will not operate.
 - If two or more Special I/O Units are assigned the same unit number, an I/O UNIT OVER error will be generated and the PC will not operate.

4-2-3 Operation Mode Switch

The operation mode switch on the back of the Unit is used to set the operation mode to either normal mode or adjustment mode (for adjusting offset and gain).

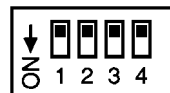

Pin number				Mode
1	2	3	4	
OFF	OFF	OFF	OFF	Normal mode
ON	OFF	OFF	OFF	Adjustment mode

Caution Do not set the pins to any combination other than those shown in the above table.
Be sure to set pins 2, 3, and 4 to OFF.

Caution Be sure to turn off the power to the PC before mounting or removing any Units.

4-3 Wiring

4-3-1 Terminal Arrangement

The signal names corresponding to the connecting terminals are as shown in the following diagram.

Voltage output 2 (+)	B0	A0	Voltage output 1 (+)
Voltage/current output 2 (-)	B1	A1	Voltage/current output 1 (-)
Current output 2 (+)	B2	A2	Current output 1 (+)
NC	B3	A3	NC
NC	B4	A4	NC
NC	B5	A5	NC
Current input 2	B6	A6	Current input 1
Voltage input 2 (+)	B7	A7	Voltage input 1 (+)
Voltage input 2 (-)	B8	A8	Voltage input 1 (-)
COM (analog 0 V)	B9	A9	COM (analog 0 V)
NC	B10	A10	NC
NC	B11	A11	NC
NC	B12	A12	NC
NC	B13	A13	NC

- Note**
1. The analog I/O numbers that can be used are set in the Data Memory (DM).
 2. The I/O signal ranges for individual inputs and outputs are set in the Data Memory (DM). They can be set in units of analog I/O numbers.
 3. The COM terminal (A9, B9) is connected to the 0-V analog circuit in the Unit. Connecting shielded input lines can improve noise resistance.

4-3-2 Internal Circuitry

The following diagrams show the internal circuitry of the analog I/O section.

Input Circuitry

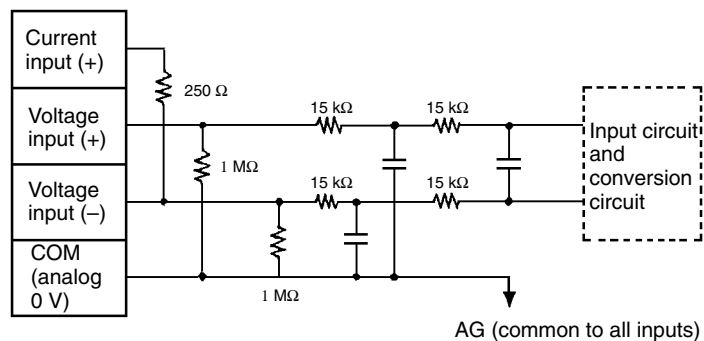

Output Circuitry (Voltage Output)

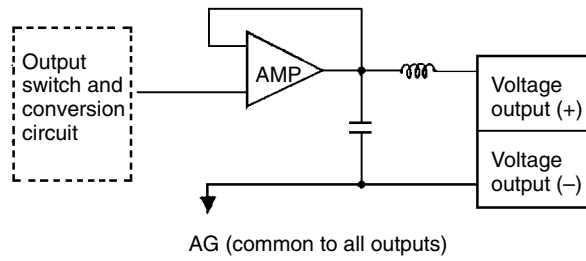

Output Circuitry (Current Output)

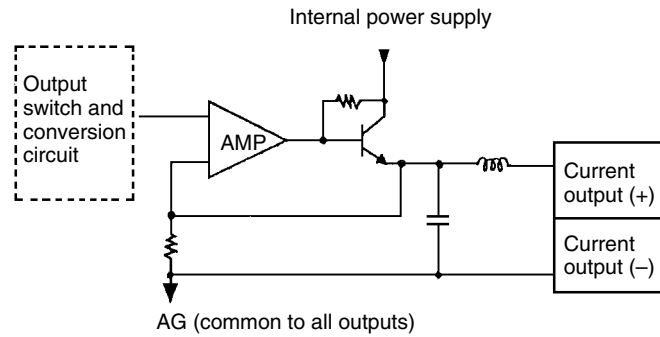

4-3-3 Line Breakage while Using Voltage Input

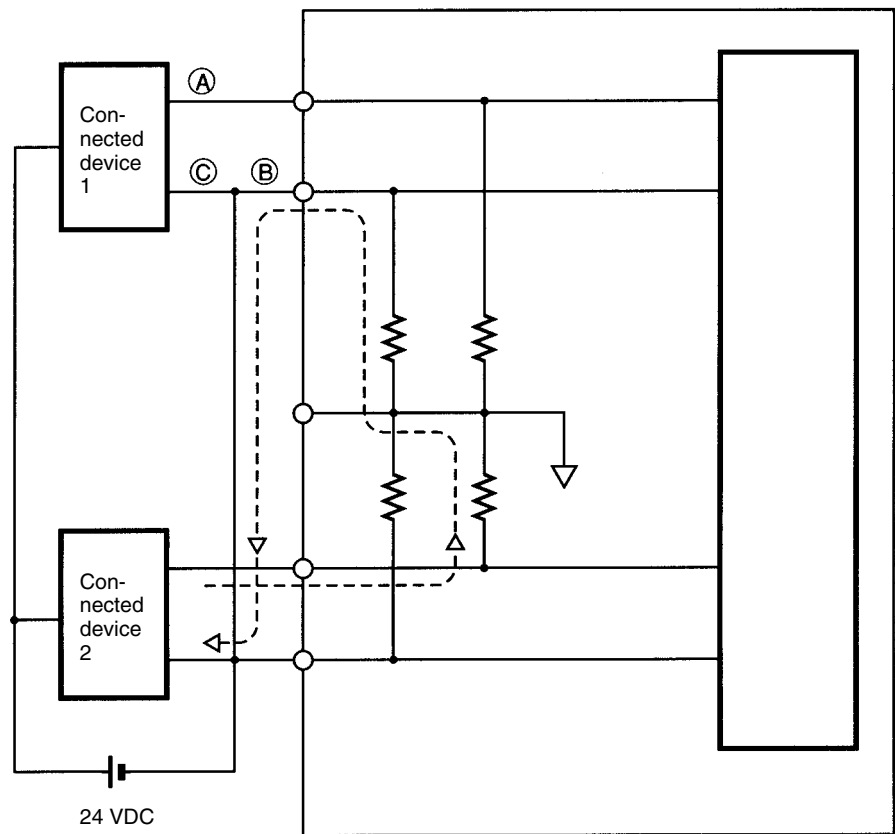

Note If the power supply is shared by two channels as shown above, while the connected device 2 outputs 5 V, approximately 1.6 V (one-third of the output voltage) is generated in input 1.

If a line breakage occurs while using the voltage input, either separate the power supply from the connected device or use an isolator for each input to avoid the following problem.

If the line breakage occurs at point A or B as shown in the preceding diagram while power is shared by the connected devices, a short-circuit line will be formed as indicated by the dotted line in the above illustration, thus generating a voltage of approximately one-third to two-thirds of the voltage output from the connected device. If this kind of voltage is generated while using the Unit at 1 to 5 V, the line breakage may not be detected. If the line breakage occurs at point C, it will not be detected because the negative (–) side is common.

In case of the current input, this kind of problem will not occur even if the power supply is shared by the connected devices.

4-3-4 I/O Wiring Example

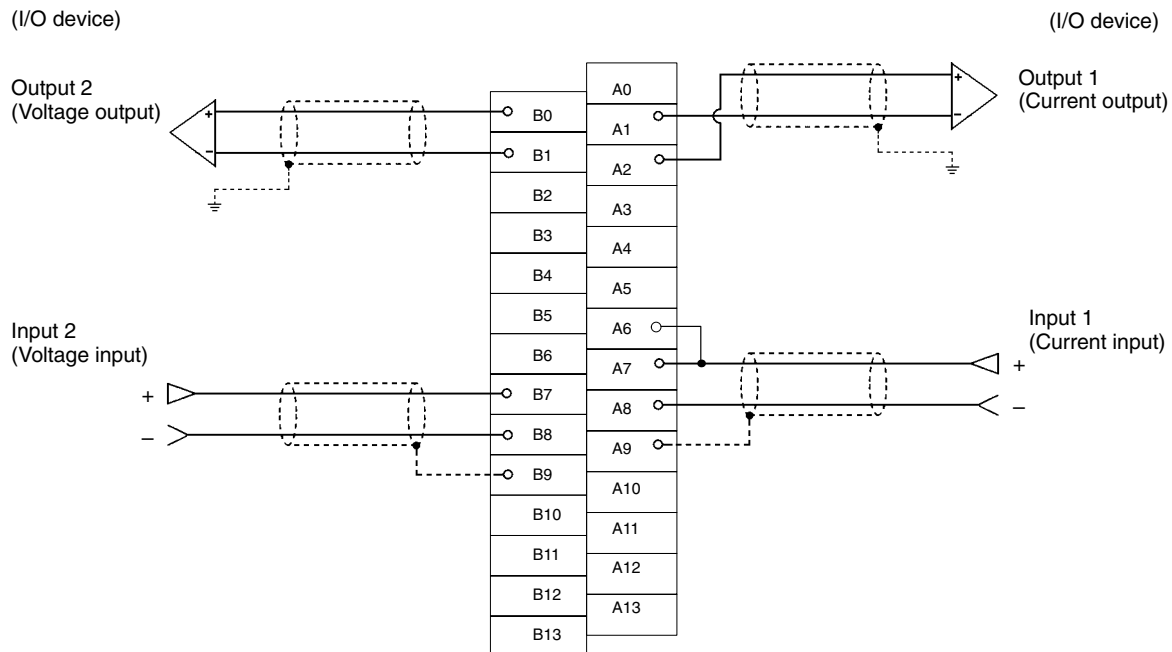

- Note**
1. When using current inputs, the voltage input terminals (V+) and current input terminals (I+) must be individually short-circuited as shown in the above diagram.
 2. Do not simultaneously connect voltage output terminals and current output terminals with the same output numbers. Voltage outputs and current outputs cannot be used at the same time with the same output numbers.
 3. For inputs that are not used, either set to "0: Do not use" in the input number settings (refer to 4-5-1 *Setting Inputs and Signal Ranges*) or short-circuit the voltage input terminals (V+) and (V–).

4. Crimp-type terminals must be used for terminal connections, and the screws must be tightened securely. Use M3 screws and tighten them to a torque of 0.5 N • m.

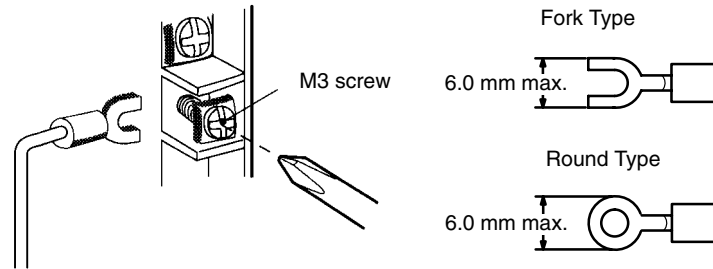

Connecting shielded cable to the Unit's COM terminals (A9, B9) can improve noise resistance.

To minimize output wiring noise, ground the output signal line to the output device.

4-3-5 I/O Wiring Considerations

When wiring inputs, apply the following points to avoid noise interference and optimize Analog I/O Unit performance.

- Use shielded twisted-pair cable for external connections.
- Route I/O cables separately from the AC cable, and do not run the Unit's cables near a main circuit cable, high voltage cable, or a non-PC load cable.
- If there is noise interference from power lines (if, for example, the power supply is shared with electrical welding devices or electrical discharge machines, or if there is a high-frequency generation source nearby) install a noise filter at the power supply input area.
- When the power supply to the PC is turned on or off, momentary voltage or current may be output from the output terminal.

4-4 IR and DM Areas

4-4-1 IR Area Allocation and Contents

IR Area Allocation

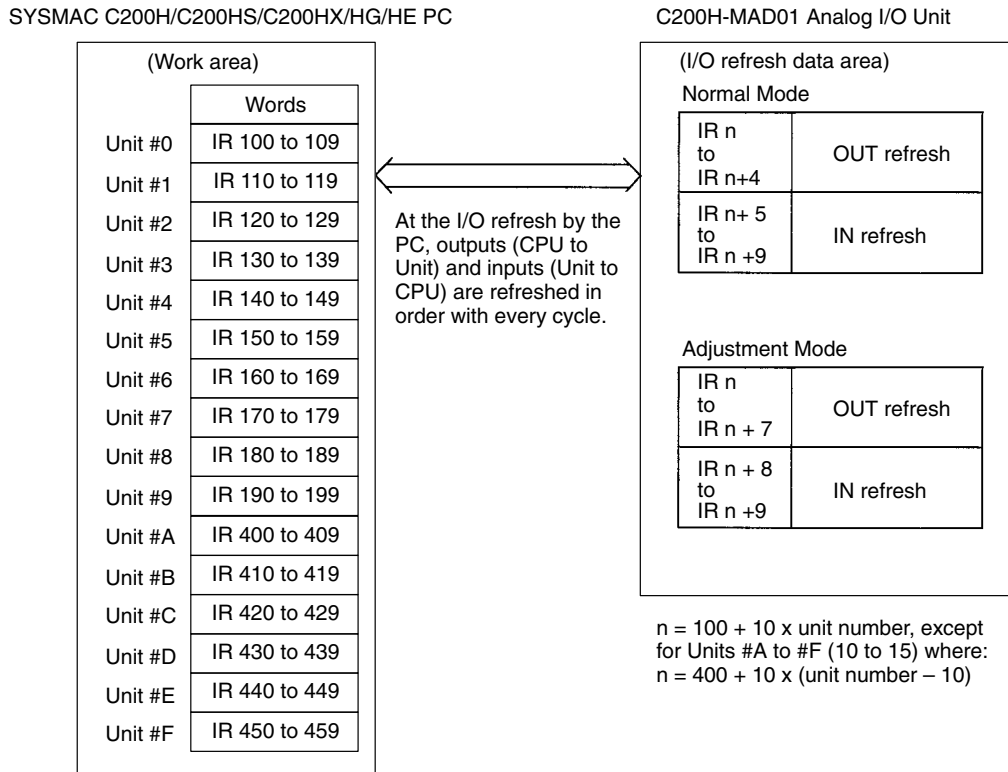

- Note**
- Switches A to F can be set for the C200HX/HG-CPU5□-E/6□-E. Setting numbers A to F for C200H, C200HS, C200HE, or C200HX/HG-CPU3□-E/4□-E PCs will cause an I/O UNIT OVER error and the Unit will not operate.
 - If two or more Special I/O Units are assigned the same unit number, an I/O UNIT OVER error will be generated and the PC will not operate.

Allocation for Normal Mode

For normal mode, set the operation mode switch on the rear panel of the Unit as shown in the following diagram.

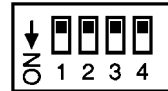

The allocation of IR words and bits is shown in the following table.

I/O	Word	Bits															
		15	14	13	12	11	10	9	8	7	6	5	4	3	2	1	0
Output (CPU to Unit)	n	Not used.								Not used.		Peak hold		Not used.		Conversion enable	
											Input 2	Input 1			Out-put 2	Out-put 1	
	n+1	Output 1 set value															
		16 ³				16 ²				16 ¹				16 ⁰			
	n+2	Output 2 set value															
n+3	Not used.																
n+4	Not used.																
Input (Unit to CPU)	n+5	Input 1 conversion value / Loop 1 calculation result															
		16 ³				16 ²				16 ¹				16 ⁰			
	n+6	Input 2 conversion value / Loop 2 calculation result															
	n+7	Not used.															
	n+8	Not used.															
n+9	Error code								Not used.		Disconnection detection		Not used.		Output setting error		
	16 ¹				16 ⁰							Input 2	Input 1			Out-put 2	Out-put 1

Note For the IR word addresses, n = 100 + 10 x unit number.
 For Units #A to #F (10 to 15), n = 400 + 10 x (unit number – 10).

Set Values and Stored Values

I/O	Item	Contents
Input	Peak value function	0: Do not use. 1: Use peak value.
	Conversion value/ Calculation result	16-bit binary data
	Disconnection detection	0: No disconnection 1: Disconnection
Output	Conversion enable	0: Stop conversion output 1: Begin conversion output
	Set value	16-bit binary data
	Output setting error	0: No error 1: Output setting error
Common	Error code	Two digits, hexadecimal (00 for no error)

The disconnection detection function can be used when the input signal range is set for 1 to 5 V (4 to 20 mA).

Input signal range	Voltage/current
1 to 5 V	0.3 V max.
4 to 20 mA	1.2 mA max.

Allocation for Adjustment Mode

For adjustment mode, set the operation mode switch on the rear panel of the Unit as shown in the following diagram. When the Unit is set for adjustment mode, the RUN indicator on the front panel of the Unit will flash.

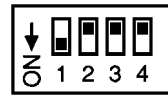

The allocation of IR words and bits is shown in the following table.

I/O	Word	Bits															
		15	14	13	12	11	10	9	8	7	6	5	4	3	2	1	0
Output (CPU to Unit)	n	Not used.								Inputs and outputs to be adjusted							
										16 ¹				16 ⁰			
	n+1	Not used.								Not used.	Clr	Set	Up	Down	Gain	Off-set	
	n+2	Not used.															
	n+3	Not used.															
	n+4	Not used.															
	n+5	Not used.															
	n+6	Not used.															
Input (Unit to CPU)	n+8	Conversion value or set value at time of adjustment															
		16 ³				16 ²				16 ¹				16 ⁰			
	n+9	Error code								Not used.		Disconnection detection		Not used.			
		16 ¹				16 ⁰						Input 2	Input 1				

Note For the IR word addresses, $n = 100 + 10 \times \text{unit number}$.
 For Units #A to #F (10 to 15), $n = 400 + 10 \times (\text{unit number} - 10)$.

Set Values and Stored Values

Item	Contents
Input or output to be adjusted	Sets input or output to be adjusted. Leftmost digit: 1 (output) or 2 (input) Rightmost digit: 1 or 2
Offset (Offset Bit)	When ON, adjusts offset deviation.
Gain (Gain Bit)	When ON, adjusts gain deviation.
Down (Down Bit)	Decrements the adjustment value while ON.
Up (Up Bit)	Increments the adjustment value while ON.
Set (Set Bit)	Sets adjusted value and writes to EEPROM.
Clr (Clear Bit)	Clears adjusted value. (Returns to default status)
Conversion value for adjustment	The conversion value for adjustment is stored as 16 bits of binary data.
Disconnection detection	0: No disconnection 1: Disconnection
Error code	Two digits, hexadecimal (00 for no error)

The disconnection detection function can be used when the input signal range is set for 1 to 5 V (4 to 20 mA).

Input signal range	Voltage/current
1 to 5 V	0.3 V max.
4 to 20 mA	1.2 mA max.

4-4-2 DM Allocation and Contents

DM Allocation

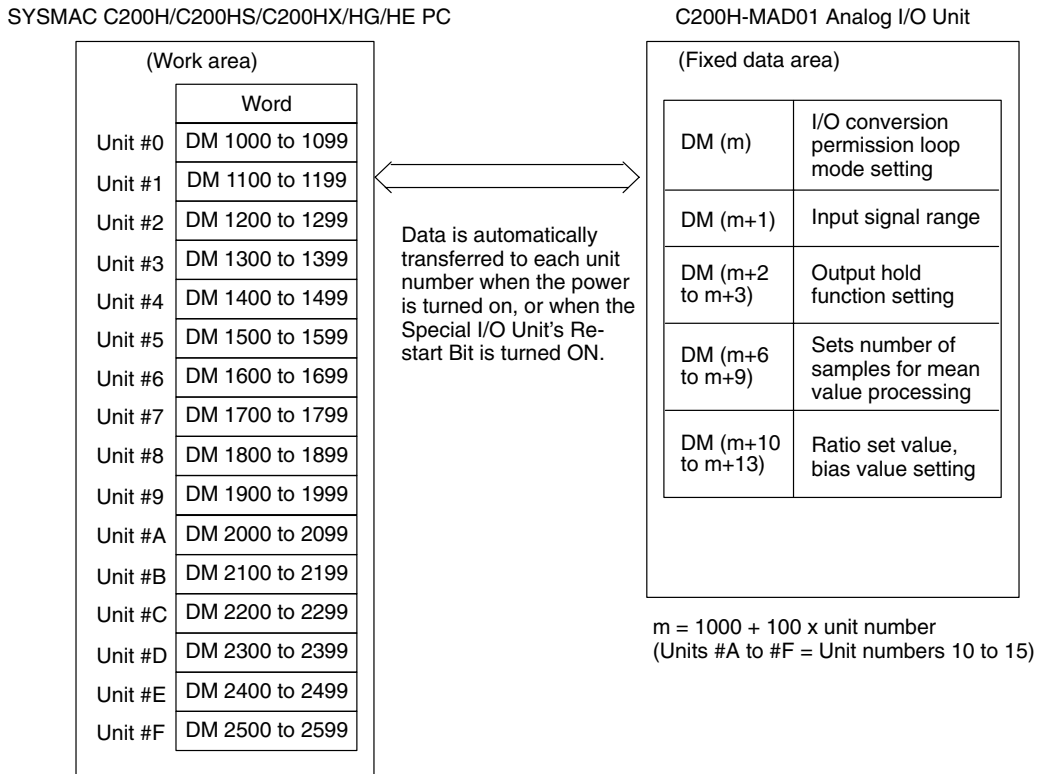

- Note**
1. Switches A to F can be set for the C200HX/HG-CPU5□-E/6□-E. Setting numbers A to F for C200H, C200HS, C200HE, or C200HX/HG-CPU3□-E/4□-E PCs will cause an I/O UNIT OVER error and the Unit will not operate.
 2. If two or more Special I/O Units are assigned the same unit number, an I/O UNIT OVER error will be generated and the PC will not operate.

DM Allocation Contents

The following table shows the allocation of DM words and bits for both normal and adjustment mode.

DM word	Bits															
	15	14	13	12	11	10	9	8	7	6	5	4	3	2	1	0
DM (m)	Not used.				Ratio conversion use designation				Not used.		Use designation		Not used.		Use designation	
					Loop 2		Loop 1				Input 2	Input 1			Output 2	Output 1
DM (m+1)	Not used.				Input signal range setting (See note 2.)				Not used.				Output signal range setting (See note 2.)			
					Input 2		Input 1						Output 2		Output 1	
DM (m+2)	Not used.								Output 1: Output status when conversion stopped							
DM (m+3)	Not used.								Output 2: Output status when conversion stopped							
DM (m+4)	Not used.															
DM (m+5)	Not used.															
DM (m+6)	Input 1: Mean value processing setting															
DM (m+7)	Input 2: Mean value processing setting															
DM (m+8)	Not used.															
DM (m+9)	Not used.															
DM (m+10)	Loop 1 (input 1 to output 1), A constant															
DM (m+11)	Loop 1 (input 1 to output 1), B constant															
DM (m+12)	Loop 2 (input 2 to output 2), A constant															
DM (m+13)	Loop 2 (input 2 to output 2), B constant															

Set Values and Stored Values

Item		Contents
Input	Use designation	0: Do not use. 1: Use.
	Input signal range	00: -10 to 10 V 01: 0 to 10 V 10: 1 to 5 V/4 to 20 mA (See note.) 11: Same as for setting "10" above.
	Mean value processing setting	0000: No mean value processing 0001: Mean value processing for 2 buffers 0002: Mean value processing for 4 buffers 0003: Mean value processing for 8 buffers 0004: Mean value processing for 16 buffers
Output	Use designation	0: Do not use. 1: Use.
	Output signal range	00: -10 to 10 V 01: 0 to 10 V 10: 1 to 5 V/4 to 20 mA (See note 2.) 11: Same as for setting "10" above.
	Output status when stopped	00: CLR 0 output 01: HOLD Hold output prior to stop 02: MAX Output maximum value of range
Loop	Ratio conversion use designation	00: Do not use. 01: Use positive gradient conversion. 10: Use negative gradient conversion. 11: Same as for setting "10" above.
	A constant	4 digits BCD (0 to 9999)
	B constant	16-bit binary data

- Note**
1. For the DM word addresses, m = 1000 + 100 x unit number (Units #A to #F = Unit numbers 10 to 15).
 2. The I/O signal range of "1 to 5 V" or "4 to 20 mA" is switched according to the input or output terminal connections.

4-5 Analog Input Functions

4-5-1 Setting Inputs and Signal Ranges

Input Numbers

The Analog I/O Unit only converts analog inputs specified by input numbers 1 and 2. In order to specify the analog inputs to be used, turn ON from a Peripheral Device the DM bits shown in the following diagram.

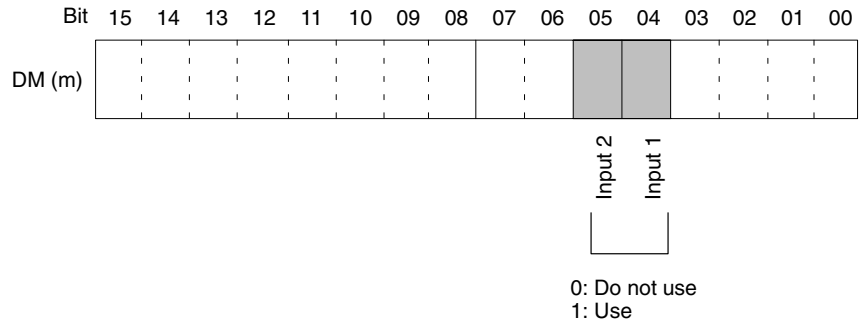

The analog input sampling interval can be shortened by setting any unused input numbers to 0.

$$\text{Sampling interval} = (1 \text{ ms}) \times (\text{Number of inputs used}) + (1\text{ms}) \times (\text{Number of outputs used (see note a)}) + (0.5\text{ms}) \times (\text{Number of loops used (see note b)})$$

Note a) Refer to 4-6 Analog Output Functions for output settings.

b) Only when using the ratio conversion function.

For the DM word addresses, $m = 1000 + 100 \times \text{unit number}$ (Units #A to #F = Unit numbers 10 to 15).

Input Signal Range

Any of four types of input signal range can be selected for each of the eight inputs (input numbers 1 and 2). In order to specify the input signal range for each input, set from a Peripheral Device the DM bits shown in the following diagram.

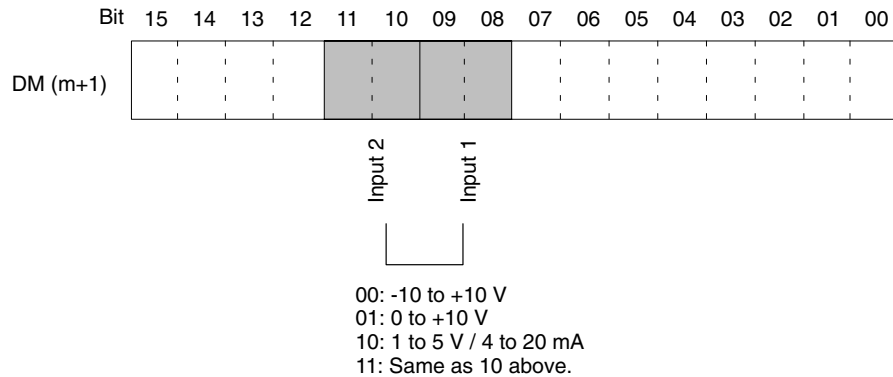

- Note**
1. For the DM word addresses, $m = 1000 + 100 \times \text{unit number}$ (Units #A to #F = Unit numbers 10 to 15).
 2. The I/O signal range of “1 to 5 V” or “4 to 20 mA” is switched according to the input terminal connections.
 3. After making the DM settings from a Peripheral Device, it will be necessary to either power up the PC again or turn ON the Special I/O Unit Restart Bit in order to transfer the contents of the DM settings to the Special I/O Unit. For details regarding the Special I/O Unit Restart Bit, refer to 4-9-4 Restarting Special I/O Units.

4-5-2 Reading Conversion Values

Analog input conversion values are stored for each input number, in IR words n+5 and n+6.

Word	Function	Stored value
n+5	Input 1 conversion value	16-bit binary data
n+6	Input 2 conversion value	

For the IR word addresses, $n = 100 + 10 \times \text{unit number}$.

For Units #A to #F (10 to 15), $n = 400 + 10 \times (\text{unit number} - 10)$.

Use MOV(21) or XFER(70) to read conversion values in the user program.

Example 1

In this example, the conversion data from only one input is read. (The unit number is #0.)

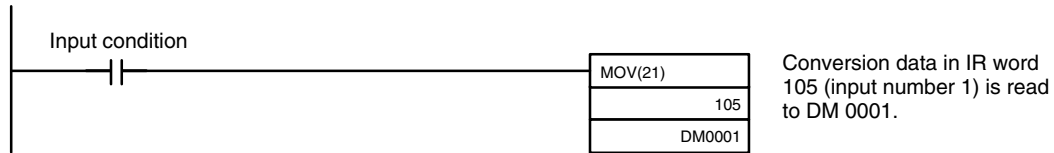

Example 2

In this example, the conversion data from multiple inputs is read. (The unit number is #0.)

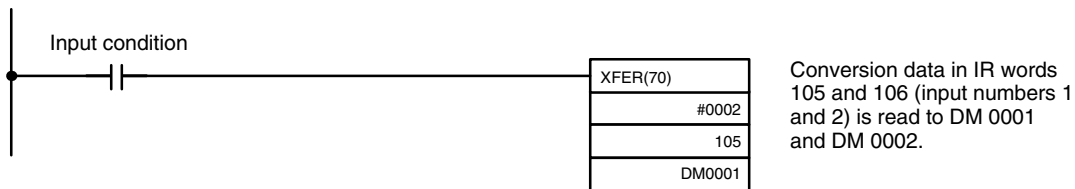

For details regarding conversion value scaling, refer to page 116, *Sample Program 5: Scaling Function*.

4-5-3 Mean Value Processing

The Analog I/O Unit can compute the mean value of the conversion values of analog inputs that have been previously sampled. Mean value processing involves an operational mean value in the history buffers, so it has no affect on the data refresh cycle. (The number of history buffers that can be set to use mean value processing is 2, 4, 8, or 16.)

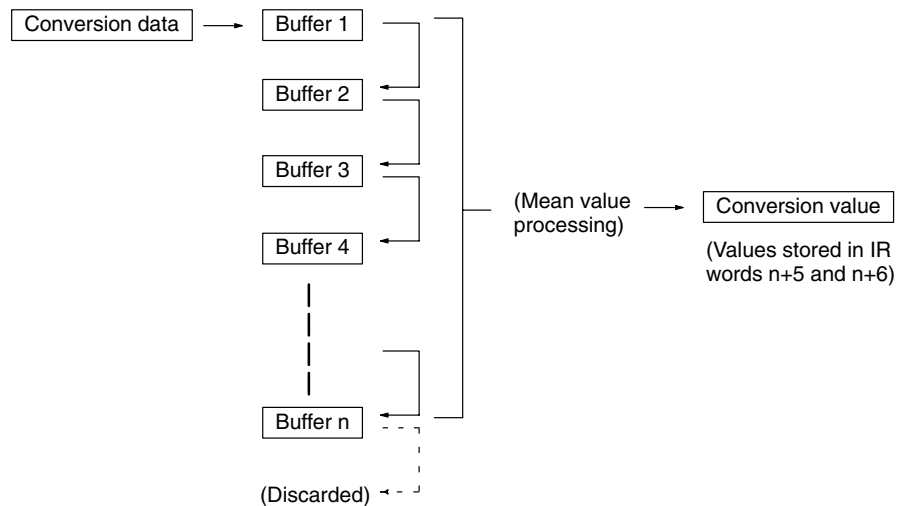

When “n” number of history buffers are being used, the first conversion data will be stored for all “n” number of history buffers immediately data conversion has begun or after a disconnection is restored.

When mean value processing is used together with the peak value function, the mean value will be held.

To specify whether or not mean value processing is to be used, and to specify the number of history buffers for mean data processing, use a Peripheral Device to make the settings in DM m+6 and DM m+7 as shown in the following table.

DM word	Function	Set value
DM (m+6)	Input 1 mean value processing	0000: No mean value processing 0001: Mean value processing with 2 buffers 0002: Mean value processing with 4 buffers
DM (m+7)	Input 2 mean value processing	0003: Mean value processing with 8 buffers 0004: Mean value processing with 16 buffers

For the DM word addresses, m = 1000 + 100 x unit number (Units #A to #F = Unit numbers 10 to 15).

Note After making the DM settings from a Peripheral Device, it will be necessary to either power up the PC again or turn ON the Special I/O Unit Restart Bit in order to transfer the contents of the DM settings to the Special I/O Unit. For details regarding the Special I/O Unit Restart Bit, refer to 4-9-4 *Restarting Special I/O Units*.

The history buffer operational means are calculated as shown below. (In this example there are four buffers.)

- 1, 2, 3...** 1. With the first cycle, the data is stored with Data 1 being in all the history buffers.

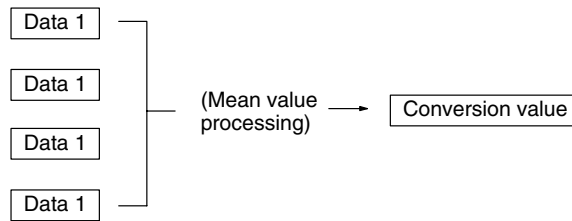

$$\text{Mean value} = (\text{Data 1} + \text{Data 1} + \text{Data 1} + \text{Data 1}) \div 4$$

2. With the second cycle, the data is stored with Data 2 being in the first history buffer.

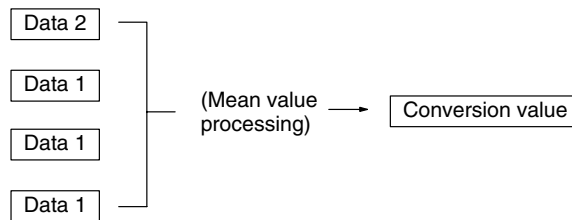

$$\text{Mean value} = (\text{Data 2} + \text{Data 1} + \text{Data 1} + \text{Data 1}) \div 4$$

3. With the third cycle, the data is stored with Data 3 being in the first history buffer.

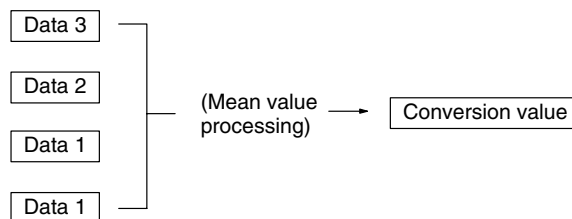

$$\text{Mean value} = (\text{Data 3} + \text{Data 2} + \text{Data 1} + \text{Data 1}) \div 4$$

4. With the fourth cycle, the Data 4 data is stored in the first history buffer.

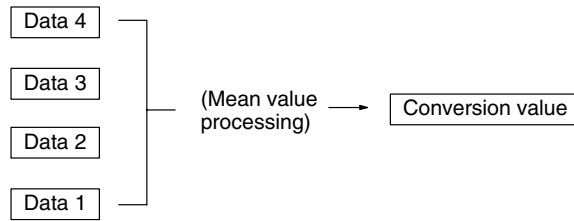

$$\text{Mean value} = (\text{Data 4} + \text{Data 3} + \text{Data 2} + \text{Data 1}) \div 4$$

5. With the fifth cycle, the data is stored with Data 5 being in the first history buffer.

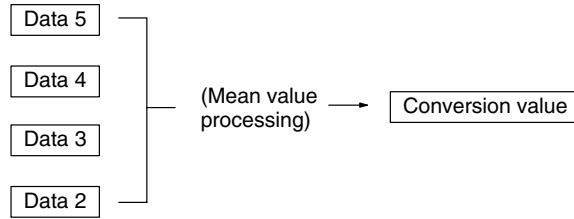

$$\text{Mean value} = (\text{Data 5} + \text{Data 4} + \text{Data 3} + \text{Data 2}) \div 4$$

When a disconnection is restored, the mean value processing function begins again from step 1.

4-5-4 Peak Value Function

The peak value function holds the maximum digital conversion value for every input (including mean value processing). This function can be used with analog input. The following diagram shows how digital conversion values are affected when the peak value function is used.

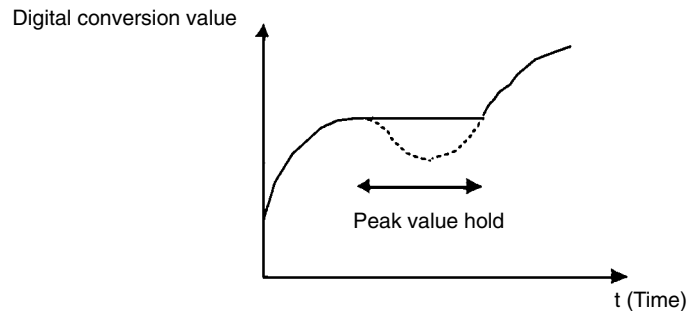

The peak value function can be set individually for each input number by turning on the respective bits (04 and 05) in IR word n.

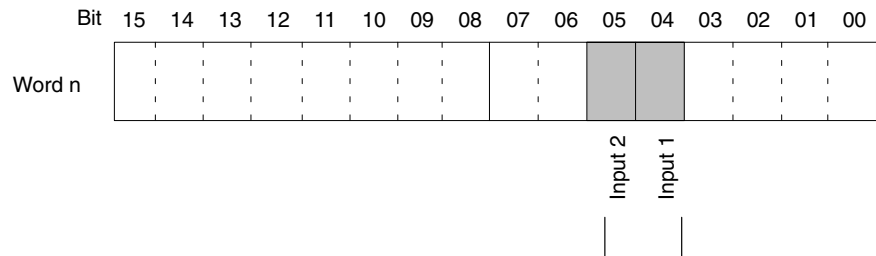

The peak hold function will be in effect for the above input numbers while their respective bits are ON. The conversion values will be reset when the bits are turned OFF.

For the IR word addresses, $n = 100 + 10 \times \text{unit number}$.
 For Units #A to #F (10 to 15), $n = 400 + 10 \times (\text{unit number} - 10)$.

In the following example, the peak value function is in effect for input number 1, and the unit number is 0.

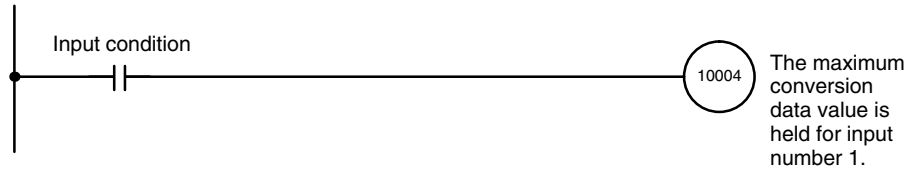

When mean value processing is used together with the peak value function, the mean value will be held.

As long as the peak value function is in effect, the peak value will be held even in the event of a disconnection.

4-5-5 Input Disconnection Detection Function

When an input signal range of 1 to 5 V (4 to 20 mA) is used, input circuit disconnections can be detected. The detection conditions for each of the input signal ranges are shown in the following table.

Range	Current/voltage
1 to 5 V	0.3 V max.
4 to 20 mA	1.2 mA max.

The input disconnection detection signals for each input number are stored in bits 04 and 05 of IR word n+9. Specify these bits as execution conditions in order to use disconnection detection in the user's program.

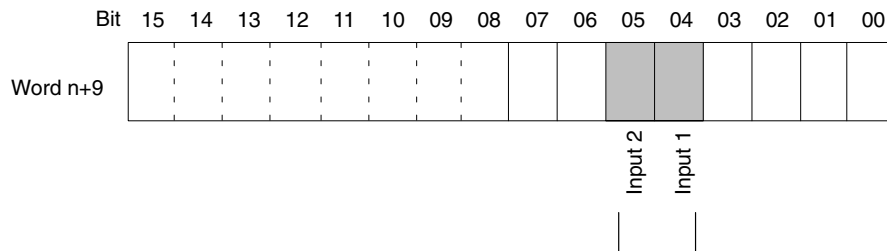

The respective bit turns ON when a disconnection is detected for a given input. When the disconnection is restored, the bit turns OFF.

For the IR word addresses, $n = 100 + 10 \times \text{unit number}$.

For Units #A to #F (10 to 15), $n = 400 + 10 \times (\text{unit number} - 10)$.

The conversion value during a disconnection will be 0000.

Disconnection detection is performed on the input voltage/current data that has been converted into digital values. Therefore, detected values may be different from those shown in the above table due to offset and gain adjustments, etc.

In the following example, the conversion value is read only if there is no disconnection at analog input number 1. (The unit number is 0.)

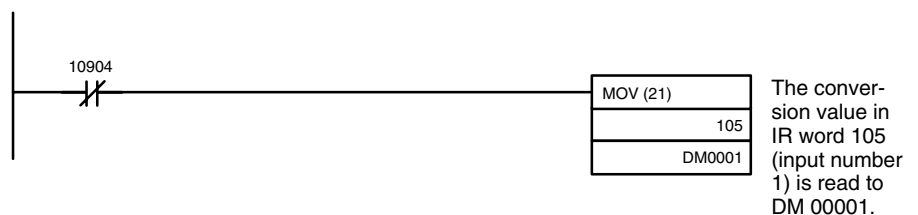

4-6 Analog Output Functions

4-6-1 Setting Outputs and Signal Ranges

Output Numbers

The Analog Output Units only convert analog outputs specified by output numbers 1 and 2. In order to specify the analog outputs to be used, use a Peripheral Device to turn ON the DM bits shown in the following diagram.

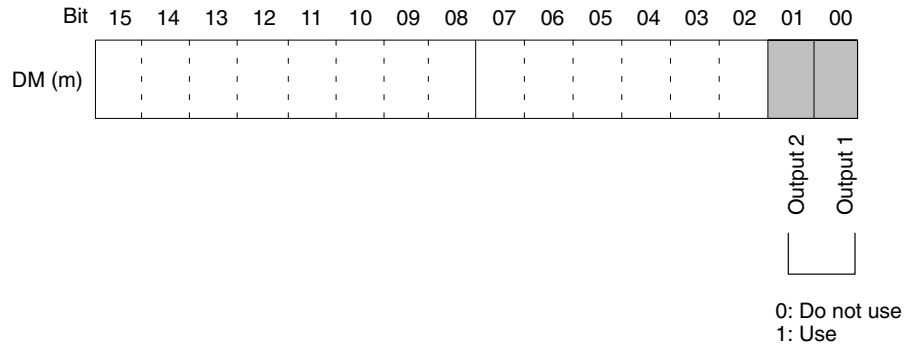

The analog output conversion cycle can be shortened by setting any unused output numbers to 0.

$$\text{Conversion cycle} = (1 \text{ ms}) \times (\text{Number of outputs used}) + (1 \text{ ms}) \times (\text{Number of outputs used (see note)})$$

Note Refer to 4-5 Analog Input Functions for input settings.

For the DM word addresses, $m = 1000 + 100 \times \text{unit number}$ (Units #A to #F = Unit numbers 10 to 15).

Output Signal Range

Any of four types of output signal range can be selected for each of the two outputs (output numbers 1 and 2). In order to specify the output signal range for each output, use a Peripheral Device to set the DM bits shown in the following diagram.

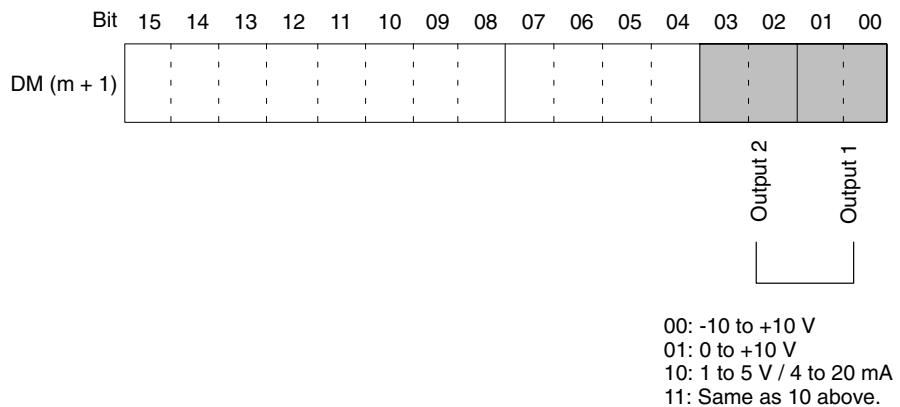

- Note**
1. For the DM word addresses, $m = 1000 + 100 \times \text{unit number}$ (Units #A to #F = Unit numbers 10 to 15).
 2. The I/O signal range of “1 to 5 V” or “4 to 20 mA” is switched according to the input terminal connections.
 3. After making the DM settings from a Peripheral Device, it will be necessary to either power up the PC again or turn ON the Special I/O Unit Restart Bit in order to transfer the contents of the DM settings to the Special I/O Unit. For details regarding the Special I/O Unit Restart Bit, refer to 4-9-4 Restarting Special I/O Units.

4-6-2 Output Hold Function

The Analog I/O Unit stops conversion under the following circumstances, and output the value set by the output hold function.

- 1, 2, 3...
1. When the Conversion Enable Bit is OFF. (Refer to 4-4-1 *IR Area Allocation and Contents* and 4-6-4 *Starting and Stopping Conversion*.)
 2. In adjustment mode, when something other than the output number is output during adjustment. (Refer to 4-8-3 *Output Offset and Gain Adjustment Procedures*.)
 3. When there is an output setting error. (Refer to 4-6-5 *Output Setting Errors* and 4-9-1 *Troubleshooting Procedures*.)
 4. When a fatal error occurs at the PC. (Refer to the *C200HX/HG/HE Programming Manual*.)

CLR, HOLD, or MAX can be selected for the output status when conversion is stopped.

Output signal range	CLR	HOLD	MAX
0 to 10 V	-0.5 V (Min.-5% of full scale)	Voltage that was output just prior to stop.	10.5 V (Max.+5% of full scale)
-10 to 10 V	0.0 V	Voltage that was output just prior to stop.	11.0 V (Max.+5% of full scale)
1 to 5 V	0.8 V (Min.-5% of full scale)	Voltage that was output just prior to stop.	5.2 V (Max.+5% of full scale)
4 to 20 mA	3.2 mA (Min.-5% of full scale)	Current that was output just prior to stop.	20.8 mA (Max.+5% of full scale)

In order to specify the the output hold function, use a Peripheral Device to set the DM words shown in the following table.

DM word	Function	Set value
DM (m+2)	Output 1: Output status when stopped	xx00: CLR 0 output xx01: HOLD Hold output value prior to stop
DM (m+3)	Output 2: Output status when stopped	xx02: MAX Output maximum value of range Set any value in the leftmost bytes (xx).

For the DM word addresses, $m = 1000 + 100 \times \text{unit number}$ (Units #A to #F = Unit numbers 10 to 15).

Note After making the DM settings from a Peripheral Device, it will be necessary to either power up the PC again or turn ON the Special I/O Unit Restart Bit in order to transfer the contents of the DM settings to the Special I/O Unit. For details regarding the Special I/O Unit Restart Bit, refer to 4-9-4 *Restarting Special I/O Units*.

4-6-3 Writing Set Values

Analog output set values are written to IR words $n+1$ and $n+2$.

Word	Function	Stored value
$n+1$	Output 1 set value	16-bit binary data
$n+2$	Output 2 set value	

For the IR word addresses, $n = 100 + 10 \times \text{unit number}$.

For Units #A to #F (10 to 15), $n = 400 + 10 \times (\text{unit number} - 10)$.

Use MOV(21) or XFER(70) to write values in the user program.

Example 1

In this example, the set value from only one input is read. (The unit number is #0.)

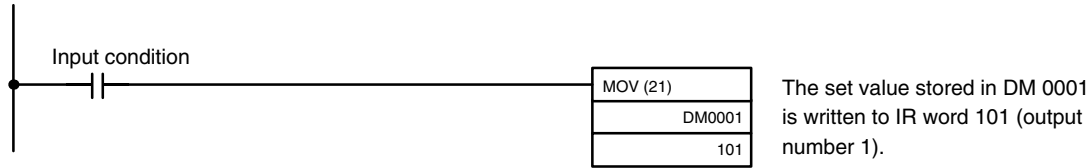

Example 2

In this example, multiple set values are written. (The unit number is #0.)

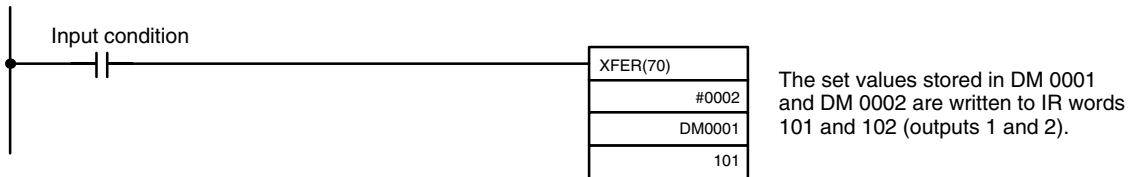

Note Turn ON the Conversion Enable Bit for converting set values into analog output.

4-6-4 Starting and Stopping Conversion

To begin analog output conversion, turn ON the corresponding Conversion Enable Bit (word n, bits 00 and 01) from the user's program.

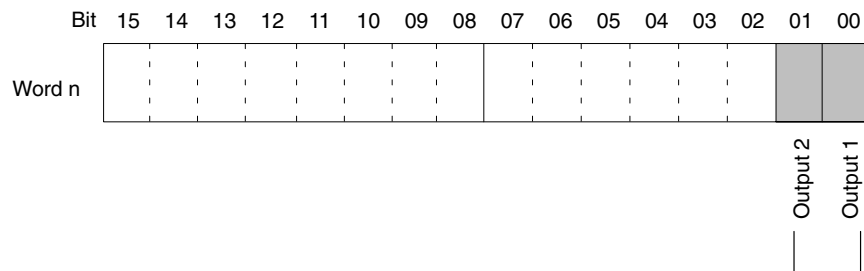

Analog conversion is executed while these bits are ON. When the bits are turned OFF, the conversion is stopped and the output data is held. (Refer to 4-6-2 Output Hold Function.)

For the IR word addresses, $n = 100 + 10 \times \text{unit number}$.

For Units #A to #F (10 to 15), $n = 400 + 10 \times (\text{unit number} - 10)$.

The analog output when conversion is stopped will differ depending on the output signal range setting. (Refer to 4-6-1 Setting Outputs and Signal Ranges.)

Conversion will not begin under the following conditions even if the Conversion Enable Bit is turned ON.

- 1, 2, 3...**
1. In adjustment mode, when something other than the output number is output during adjustment. (Refer to 3-6-1 Adjustment Mode Operational Flow.)
 2. When there is an output setting error. (Refer to 4-8-3 Output Offset and Gain Adjustment Procedures and 4-9-2 Errors Detected by Analog I/O Unit.)
 3. When a fatal error occurs at the PC. (Refer to the C200HX/HG/HE Programming Manual.)

In this example, conversion is begun for analog output number 1. (The unit number is #0.)

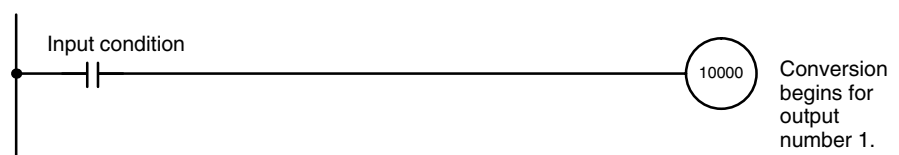

4-6-5 Output Setting Errors

If the analog output set value is outside of the range, a setting error signal will be stored in IR word n+9 (bits 00 and 02). To use disconnection detection with the user's program, set these bits as execution conditions in the ladder program.

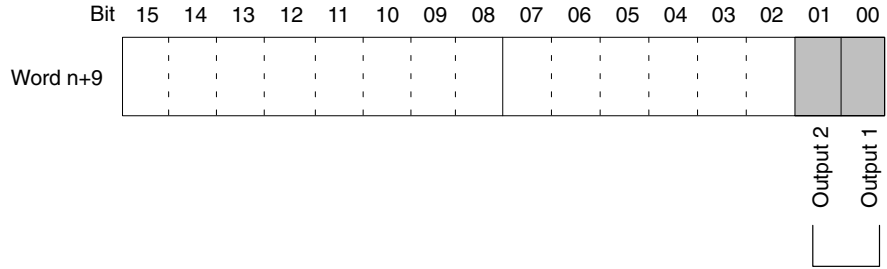

When a setting error is detected for a particular output, the corresponding bit turns ON. When the error is cleared, the bit turns OFF.

For the IR word addresses, $n = 100 + 10 \times \text{unit number}$.

For Units #A to #F (10 to 15), $n = 400 + 10 \times (\text{unit number} - 10)$.

The voltage or current for an output number at which a setting error has occurred will be output according to the output hold function.

In this example, conversion output is executed only if no error has occurred at analog output number 1. (The unit number is #0.)

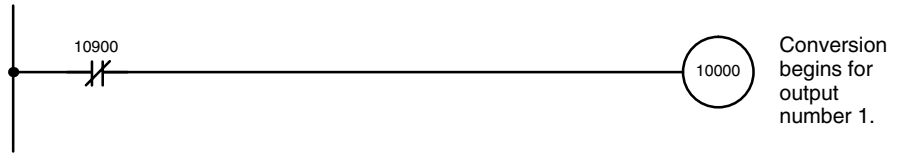

4-7 Ratio Conversion Function

The Analog I/O Unit has a ratio conversion function that enables it to perform analog-to-analog conversions by itself, without utilizing the PC. It can use either Loop 1 (input number 1 → output number 1) or Loop 2 (input number 2 → output number 2).

Input 1 → Ratio bias calculation → Output 1

Input 2 → Ratio bias calculation → Output 2

The relationship between the analog input and the analog output is expressed by the following conversion equations.

$$(\text{Analog output}) = A \times (\text{Analog input}) + B$$

Positive Gradient Conversion

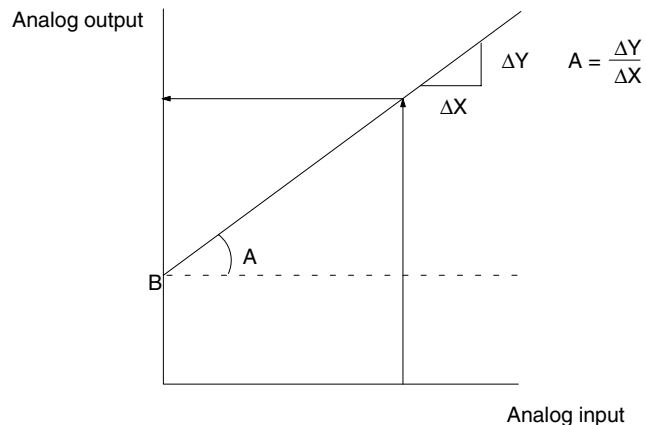

A: Ratio set value

0 to 99.99 (BCD)

B: Bias

8000 to 7FFF (16-bit binary data)

Negative Gradient Conversion

$$(\text{Analog output}) = F - A \times (\text{Analog input}) + B$$

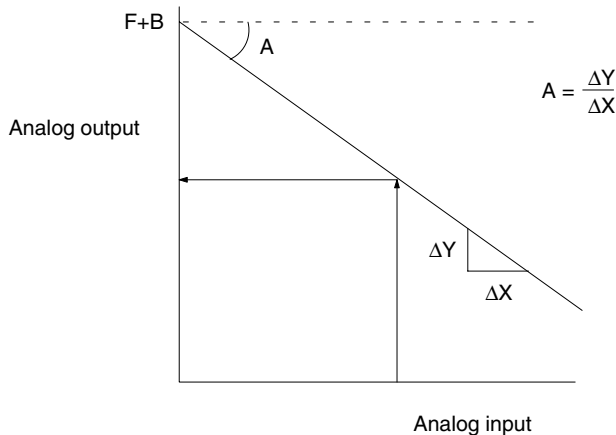

- F: Output range maximum
- A: Ratio set value 0 to 99.99 (BCD)
- B: Bias 8000 to 7FFF (16-bit binary data)

Specifying I/O Relationships

To specify the use of Loop 1 and Loop 2 and their I/O relationships, set bits 08 to 11 of DM word m as shown in the following diagram.

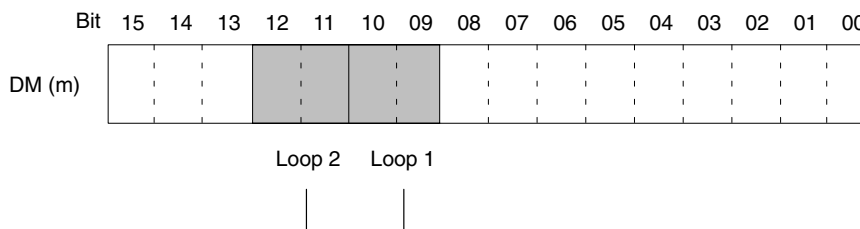

- 00: Do not use.
- 01: Use positive gradient conversion.
- 10: Use negative gradient conversion.
- 11: Same as 10 above.

The response time of ratio conversion (input to output conversion) is 2.5 ms. For the DM word addresses, $m = 1000 + 100 \times \text{unit number}$ (Units #A to #F = Unit numbers 10 to 15).

Specifying Ratio Set Value and Bias

The ratio set value (A) and the bias (B) are set in the four DM words from DM m+10 to DM m+13.

DM word	Function	Set value
DM (m+10)	Loop 1 (input 1 → output 1), A constant	BCD 0 to 9999 (0.00 to 99.99; unit: 0.01)
DM (m+11)	Loop 1 (input 1 → output 1), B constant	16-bit binary data
DM (m+12)	Loop 2 (input 2 → output 2), A constant	BCD 0 to 9999 (0.00 to 99.99; unit: 0.01)
DM (m+13)	Loop 2 (input 2 → output 2), B constant	16-bit binary data

For the DM word addresses, $m = 1000 + 100 \times \text{unit number}$ (Units #A to #F = Unit numbers 10 to 15).

Note After making the DM settings from a Peripheral Device, it will be necessary to either power up the PC again or turn ON the Special I/O Unit Restart Bit in order to transfer the contents of the DM settings to the Special I/O Unit. For details regarding the Special I/O Unit Restart Bit, refer to 4-9-4 *Restarting Special I/O Units*.

4-8 Offset and Gain Adjustment

This function is designed to calibrate inputs or outputs depending on devices to be connected.

4-8-1 Adjustment Mode Operational Flow

The following diagram shows the flow of operations when using the adjustment mode for adjusting offset and gain.

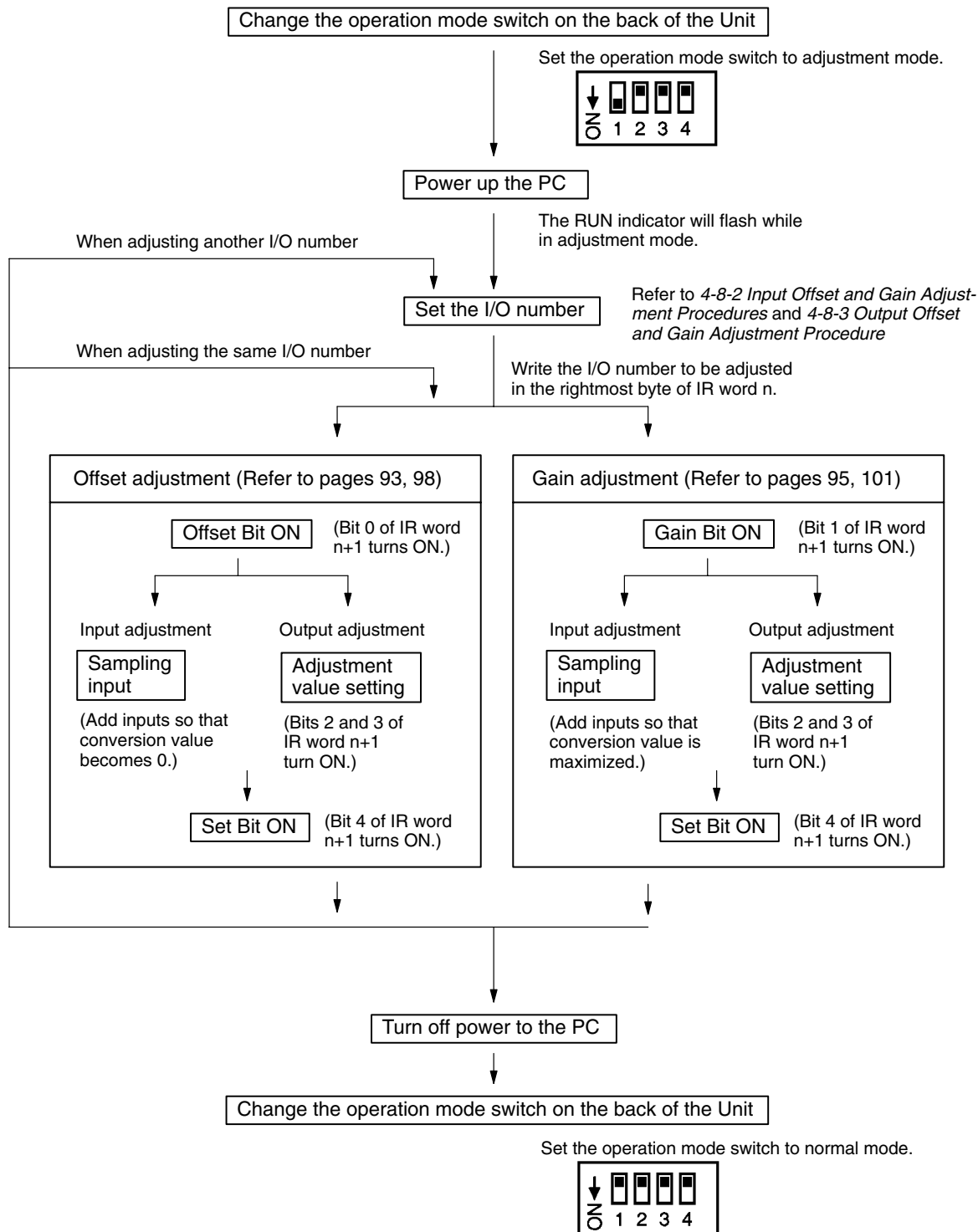

Caution Be sure to turn off the power to the PC before mounting or removing any Units. If the I/O table is registered in the PC, an I/O setting error may occur, not allowing any adjustment. In such a case, either cancel the I/O table or create the I/O table again. When making adjustments, be sure to perform both the offset adjustment and gain adjustment.

Note Input adjustments can be performed more accurately in conjunction with mean value processing.

4-8-2 Input Offset and Gain Adjustment Procedures

Specifying Input Number to be Adjusted

To specify the input number to be adjusted, write the value to the rightmost byte of IR word n as shown in the following diagram.

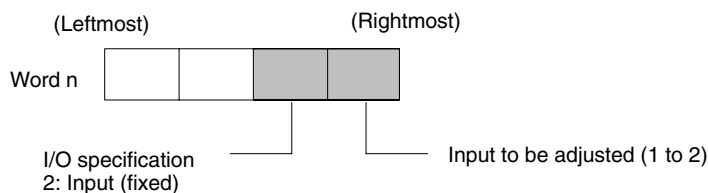

For the IR word addresses, $n = 100 + 10 \times \text{unit number}$.
 For Units #A to #F (10 to 15), $n = 400 + 10 \times (\text{unit number} - 10)$.

The following example uses input number 1 adjustment for illustration. (The unit number is 0.)

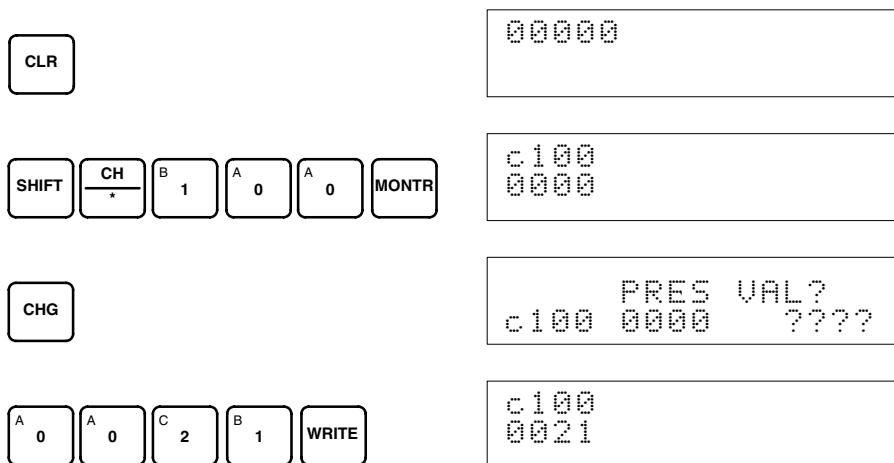

Bits Used for Adjusting Offset and Gain

The IR word n+1 bits shown in the following diagram are used for adjusting offset and gain.

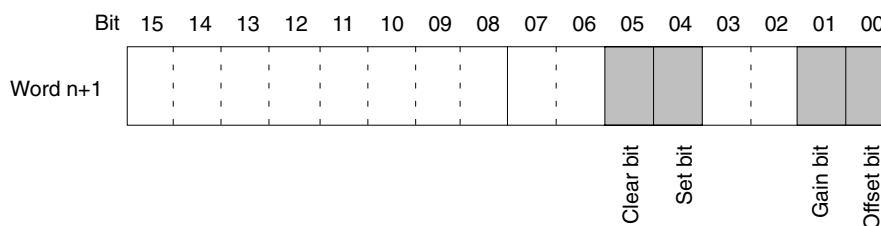

Offset Adjustment

The procedure for adjusting the analog input offset is explained below. As shown in the following diagram, the offset is adjusted by sampling inputs so that the conversion value becomes 0.

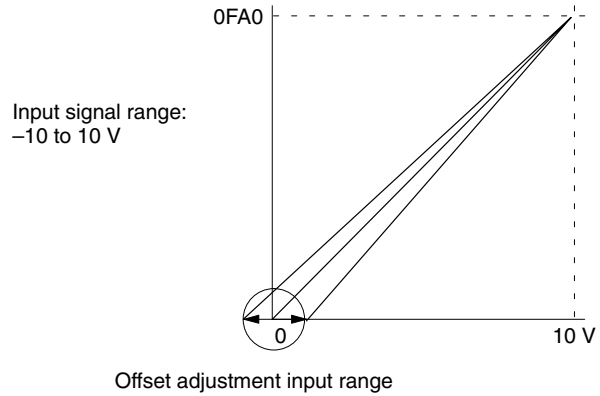

The following example uses input number 1 adjustment for illustration. (The unit number is 0.)

- 1, 2, 3...** 1. Turn ON bit 00 (the Offset Bit) of IR word n+1. (Hold the ON status.)

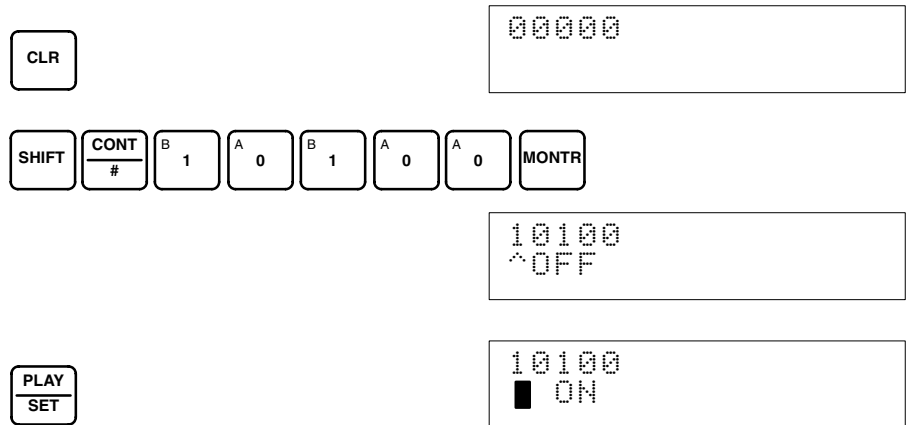

The analog input's digital conversion values while the Offset Bit is ON will be monitored in IR word n+8.

2. Check whether the input devices are connected.

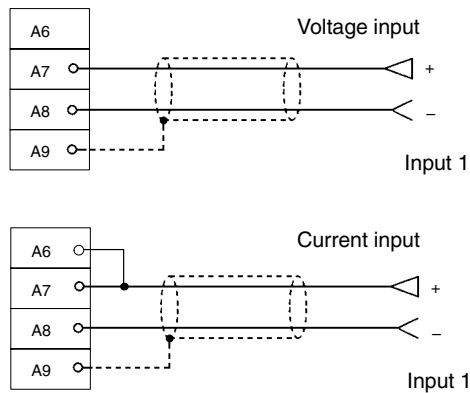

- Input the voltage or current so that the conversion value becomes 0000. The following table shows the the offset adjustment voltages and currents to be input according to the input signal range.

Input signal range	Input voltage/current	Input range
0 to 10 V	0 V	-0.5 to 0.5 V
-10 to 10 V	0 V	-1.0 to 1.0 V
1 to 5 V	1 V	0.8 to 1.2 V
4 to 20 mA	4 mA	3.2 to 4.8 mA

- With the voltage or current having been input so that the conversion value for the Analog Input Unit is 0000, turn bit 04 (the Set Bit) of IR word n+1 ON and then OFF again.



```
10104 10100
^OFF ^ ON
```



```
10104 10100
■ ON ^ ON
```



```
10104 10100
■ ON ^ ON
```

While the Offset Bit is ON, the offset value will be saved to the Unit's EEPROM when the Set Bit turns ON.

- To finish the offset adjustment, turn OFF bit 00 (the Offset Bit) of IR word n+1.



```
10100 10104
^ ON ^OFF
```



```
10100 10104
■ OFF ^OFF
```

Caution Do not turn OFF the power supply or restart the Unit while the Set Bit is ON (data is being written to the EEPROM). Otherwise, illegal data may be written in the Unit's EEPROM and "Special I/O Unit Errors" may occur when the power supply is turned ON or when the Unit is restarted, causing a malfunction. When making adjustments, be sure to perform both the offset adjustment and gain adjustment.

Note The EEPROM can be overwritten 50,000 times.

Gain Adjustment

The procedure for adjusting the analog input gain is explained below. As shown in the following diagram, the gain is adjusted by sampling inputs so that the conversion value is maximized.

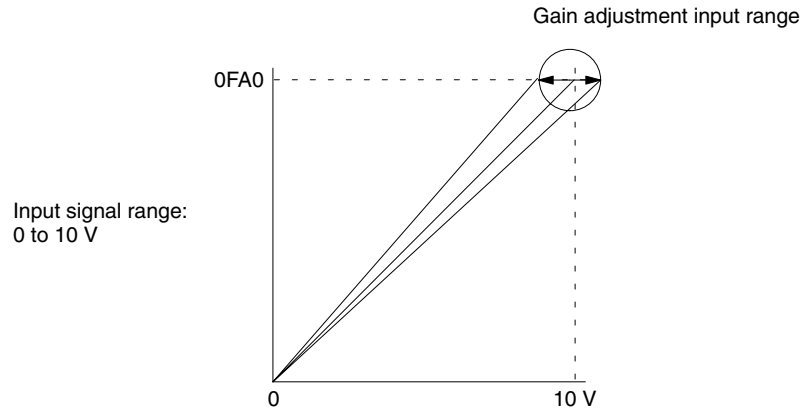

The following example uses input number 1 adjustment for illustration. (The unit number is 0.)

- 1, 2, 3...** 1. Turn ON bit 01 (the Gain Bit) of IR word n+1. (Hold the ON status.)



```
10101
^OFF
```



```
10101
■ ON
```

The analog input's digital conversion values while the Gain Bit is ON will be monitored in IR word n+8.

2. Check whether the input devices are connected.

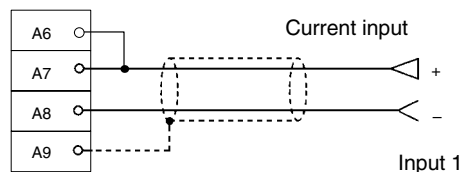
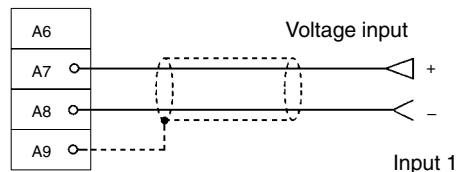

3. Input the voltage or current so that the conversion value is maximized (0FA0 or 07D0). The following table shows the the gain adjustment voltages and currents to be input according to the input signal range.

Input signal range	Input voltage/current	Input range
0 to 10 V	10 V	9.5 to 10.5 V
-10 to 10 V	10 V	9.0 to 11.0 V
1 to 5 V	5 V	4.8 to 5.2 V
4 to 20 mA	20 mA	19.2 to 20.8 mA

- With the voltage or current having been input so that the conversion value for the Analog I/O Unit is maximized (0FA0 or 07D0), turn bit 04 (the Set Bit) of IR word n+1 ON and then OFF again.



```
10104 10100
^OFF ^ ON
```



```
10104 10100
█ ON ^ ON
```



```
10104 10100
█ OFF ^ ON
```

While the Gain Bit is ON, the gain value will be saved to the Unit's EEPROM when the Set Bit turns ON.

- To finish the gain adjustment, turn OFF bit 01 (the Gain Bit) of IR word n+1.



```
10101 10104
^ ON ^ OFF
```



```
10101 10104
█ OFF ^ OFF
```

Caution Do not turn OFF the power supply or restart the Unit while the Set Bit is ON (data is being written to the EEPROM). Otherwise, illegal data may be written in the Unit's EEPROM and "Special I/O Unit Errors" may occur when the power supply is turned ON or when the Unit is restarted, causing a malfunction. When making adjustments, be sure to perform both the offset adjustment and gain adjustment.

Note The EEPROM can be overwritten 50,000 times.

Clearing Offset and Gain Adjusted Values

Follow the procedure outlined below to return the offset and gain adjusted values to their default settings.

The following example uses input number 1 adjustment for illustration. (The unit number is 0.)

- 1, 2, 3... 1. Turn ON bit 05 (the Clear Bit) of IR word n+1. (Hold the ON status.) Regardless of the input value, 0000 will be monitored in IR word n+8.



```
10105
^OFF
```



```
10105
█ ON
```

2. Turn bit 04 of IR word n+1 ON and then OFF again.



```
10104 10105
^OFF  ^ ON
```



```
10104 10105
█ ON  ^ ON
```



```
10104 10105
█ OFF ^ ON
```

While the Clear Bit is ON, the default offset and gain values will be saved to the Unit's EEPROM when the Set Bit turns ON.

3. To finish the clearing of adjusted values, turn OFF bit 05 (the Clear Bit) of IR word n+1.



```
10105 10104
^ ON  ^OFF
```



```
10105 10104
█ OFF ^OFF
```

Caution Do not turn OFF the power supply or restart the Unit while the Set Bit is ON (data is being written to the EEPROM). Otherwise, illegal data may be written in the Unit's EEPROM and "Special I/O Unit Errors" may occur when the power supply is turned ON or when the Unit is restarted, causing a malfunction. When making adjustments, be sure to perform both the offset adjustment and gain adjustment.

Note The EEPROM can be overwritten 50,000 times.

4-8-3 Output Offset and Gain Adjustment Procedures

Specifying Output Number to be Adjusted

To specify the output number to be adjusted, write the value to the rightmost byte of IR word n as shown in the following diagram.

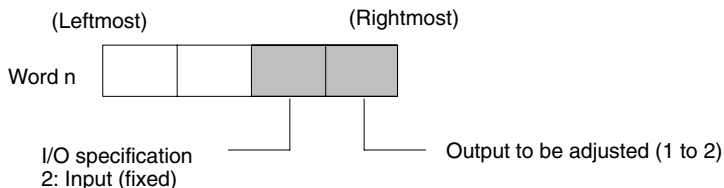

For the IR word addresses, $n = 100 + 10 \times \text{unit number}$.

For Units #A to #F (10 to 15), $n = 400 + 10 \times (\text{unit number} - 10)$.

The following example uses output number 1 adjustment for illustration. (The unit number is 0.)



```
00000
```



```
c 100
0000
```

CHG	PRES VAL? c100 0000 ????
A 0	c100 0011
A 0	
B 1	
B 1	
WRITE	

Bits Used for Adjusting Offset and Gain

The IR word n+1 bits shown in the following diagram are used for adjusting offset and gain.

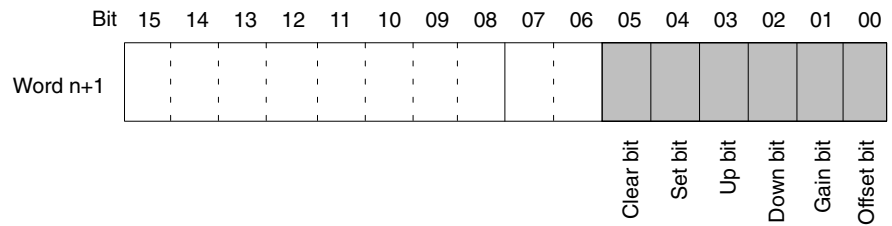

Offset Adjustment

The procedure for adjusting the analog output offset is explained below. As shown in the following diagram, the set value is adjusted so that the analog output reaches the standard value (0V/1V/4mA).

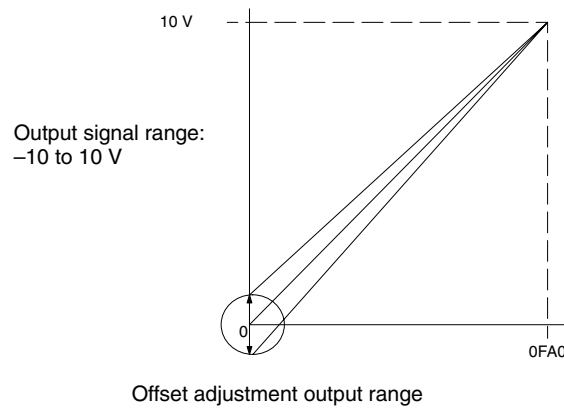

The following example uses output number 1 adjustment for illustration. (The unit number is 0.)

- 1, 2, 3...** 1. Turn ON bit 00 (the Offset Bit) of IR word n+1. (Hold the ON status.)

CLR	00000
SHIFT	10100 ^OFF
CONT #	
B 1	10100 ■ ON
A 0	
B 1	
A 0	
A 0	
MONTR	
PLAY	
SET	

2. Check whether the output devices are connected.

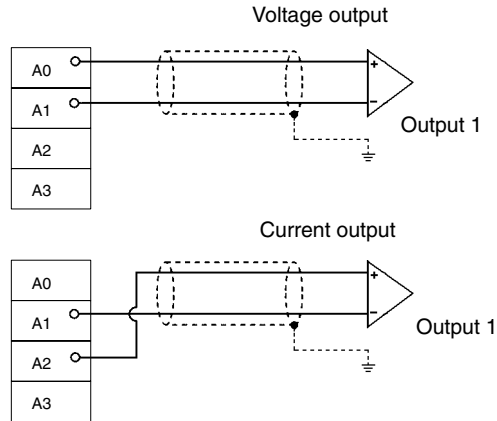

3. Monitor IR word n+8 and check the set value while the Offset Bit is ON.

CLR 00000

SHIFT CH B 1 A 0 8 MONTR

c100
0000

4. Change the set value so that the output voltage and output current are as shown in the following table. The data can be set within the indicated ranges.

Output signal range	Output voltage/current	Output range
0 to 10 V	0 V	FF38 to 00C8
-10 to 10 V	0 V	
1 to 5 V	1 V	
4 to 20 mA	4 mA	

Change the set value, using the Up Bit (bit 03 of word n+1) and the Down Bit (bit 02 of word n+1).

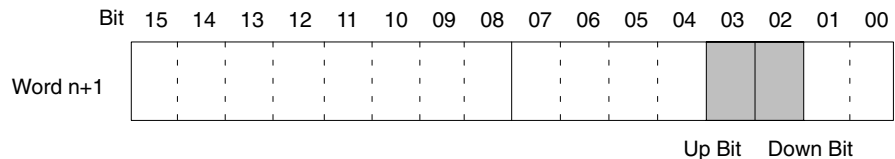

While the Up Bit is ON, the resolution will be increased by 1 every 0.5 seconds. After it has been ON for 3 seconds, the resolution will be increased by 1 every 0.1 seconds.

While the Down Bit is ON, the resolution will be decreased by 1 every 0.5 seconds. After it has been ON for 3 seconds, the resolution will be decreased by 1 every 0.1 seconds.



```
10102 c108
^OFF 0000
```

The bit will remain ON until the output becomes an appropriate value, at which time, it will turn OFF.



```
10102 c108
■ ON FFFF
```



```
10102 c108
■ OFF FFFF
```

5. Check the 0V/1V/4mA output, and then turn bit 04 (the Set Bit) of IR word n+1 ON and then OFF again.



```
10104 10102 c108
^OFF ^ OFF FFFF
```



```
10104 10102 c108
■ ON ^ OFF FFFF
```



```
10104 10102 c108
■ OFF ^ OFF FFFF
```

While the Offset Bit is ON, the offset value will be saved to the Unit's EEPROM when the Set Bit turns ON.

6. To finish the offset adjustment, turn OFF bit 00 (the Offset Bit) of IR word n+1.



```
10100 10104
^ ON ^OFF
```



```
10100 10104
■ OFF ^OFF
```

Caution Do not turn OFF the power supply or restart the Unit while the Set Bit is ON (data is being written to the EEPROM). Otherwise, illegal data may be written in the Unit's EEPROM and "Special I/O Unit Errors" may occur when the power supply is turned ON or when the Unit is restarted, causing a malfunction. When making adjustments, be sure to perform both the offset adjustment and gain adjustment.

Note The EEPROM can be overwritten 50,000 times.

Gain Adjustment

The procedure for adjusting the analog output gain is explained below. As shown in the following diagram, the set value is adjusted so that the analog output is maximized (to 10V/5V/20mA).

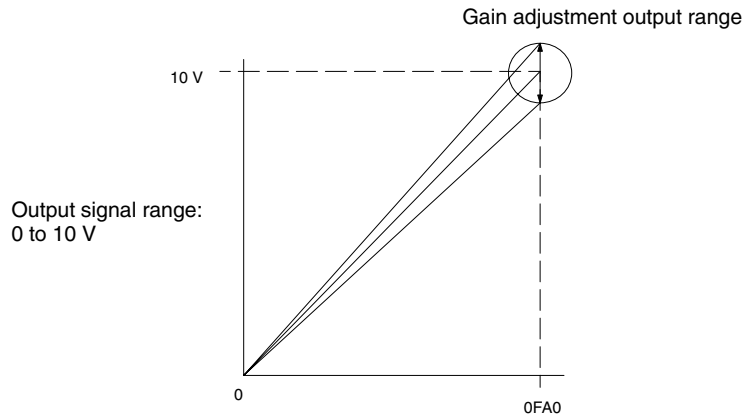

The following example uses output number 1 adjustment for illustration. (The unit number is 0.)

- 1, 2, 3... 1. Turn ON bit 01 (the Gain Bit) of IR word n+1. (Hold the ON status.)

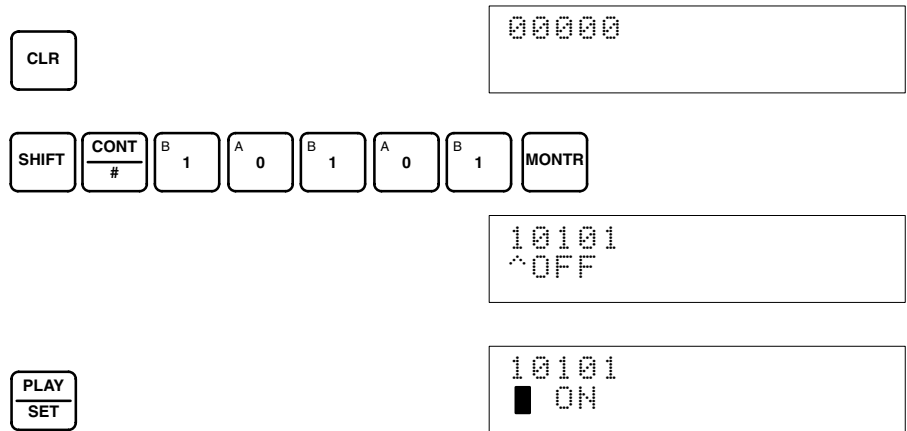

2. Check whether the output devices are connected.

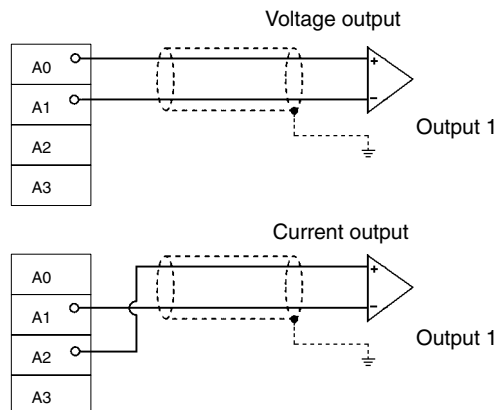

3. Monitor IR word n+8 and check the set value while the Gain Bit is ON.

CLR

00000

SHIFT CH B 1 A 0 8 MONTR

c108
0FA0

4. Change the set value so that the output voltage and output current are as shown in the following table. The data can be set within the indicated ranges.

Output signal range	Output voltage/current	Output range
0 to 10 V	10 V	0ED8 to 1068
-10 to 10 V	10 V	0708 to 0898
1 to 5 V	5 V	0ED8 to 1068
4 to 20 mA	20 mA	0ED8 to 1068

Change the set value, using the Up Bit (bit 03 of word n+1) and the Down Bit (bit 02 of word n+1).

Bit 15 14 13 12 11 10 09 08 07 06 05 04 03 02 01 00

Word n+1

Up Bit Down Bit

While the Up Bit is ON, the resolution will be increased by 1 every 0.5 seconds. After it has been ON for 3 seconds, the resolution will be increased by 1 every 0.1 seconds.

While the Down Bit is ON, the resolution will be decreased by 1 every 0.5 seconds. After it has been ON for 3 seconds, the resolution will be decreased by 1 every 0.1 seconds.

SHIFT CONT B 1 A 0 B 1 A 0 C 2 MONTR

10102 c108
^OFF 0FA0

The bit will remain ON until the output becomes an appropriate value, at which time, it will turn OFF.

PLAY SET

10102 c108
■ ON 0F9F

REC RESET

10102 c108
■ OFF 0F9F

5. Check the 10V/5V/20mA output, and then turn bit 04 (the Set Bit) of IR word n+1 ON and then OFF again.

SHIFT CONT
B
1 A
0 B
1 A
0 E
4 MONTR

```
10104 10102 c108
^OFF ^ OFF 0F9F
```

PLAY
SET

```
10104 10102 c108
█ ON ^ OFF 0F9F
```

REC
RESET

```
10104 10102 c108
█ OFF ^ OFF 0F9F
```

While the Gain Bit is ON, the gain value will be saved to the Unit's EEPROM when the Set Bit turns ON.

6. To finish the gain adjustment, turn OFF bit 01 (the Gain Bit) of IR word n+1.

SHIFT CONT
B
1 A
0 B
1 A
0 B
1 MONTR

```
10101 10104
^ ON ^OFF
```

REC
RESET

```
10101 10104
█ OFF ^OFF
```

Caution Do not turn OFF the power supply or restart the Unit while the Set Bit is ON (data is being written to the EEPROM). Otherwise, illegal data may be written in the Unit's EEPROM and "Special I/O Unit Errors" may occur when the power supply is turned ON or when the Unit is restarted, causing a malfunction. When making adjustments, be sure to perform both the offset adjustment and gain adjustment.

Note The EEPROM can be overwritten 50,000 times.

Clearing Offset and Gain Adjusted Values

Follow the procedure outlined below to return the offset and gain adjusted values to their default settings.

The following example uses output number 1 adjustment for illustration. (The unit number is 0.)

1, 2, 3... 1. Turn ON bit 05 (the Clear Bit) of IR word n+1. (Hold the ON status.) Regardless of the set value, 0000 will be monitored in IR word n+8.

SHIFT CONT
B
1 A
0 B
1 A
0 F
5 MONTR

```
10105
^OFF
```

PLAY
SET

```
10105
█ ON
```

2. Turn bit 04 of IR word n+1 ON and then OFF again.



```
10104 10105
^OFF ^ ON
```



```
10104 10105
■ ON ^ ON
```



```
10104 10105
■ OFF ^ ON
```

While the Clear Bit is ON, the default offset and gain values will be saved to the Unit's EEPROM when the Set Bit turns ON.

3. To finish the clearing of adjusted values, turn OFF bit 05 (the Clear Bit) of IR word n+1.



```
10105 10104
^ ON ^OFF
```



```
10105 10104
■ OFF ^OFF
```

Caution Do not turn OFF the power supply or restart the Unit while the Set Bit is ON (data is being written to the EEPROM). Otherwise, illegal data may be written in the Unit's EEPROM and "Special I/O Unit Errors" may occur when the power supply is turned ON or when the Unit is restarted, causing a malfunction.

Note The EEPROM can be overwritten 50,000 times.

4-9 Error Processing

4-9-1 Troubleshooting Procedure

Use the following procedure for troubleshooting Analog Input Unit errors.

- 1, 2, 3...
1. Error occurs.
 2. Is the ERROR indicator lit?
 - Yes: Error detected by Analog I/O Unit
(Refer to 4-9-2 Errors Detected by Analog I/O Unit.)
 - No: Go to the next step.
 3. Is the RUN indicator lit?
 - Yes: Error detected by CPU Unit
(Refer to 4-9-3 Errors Detected by CPU Unit.)
Check whether the operation mode switch on the back of the Analog I/O Unit is set correctly.
 - No: Refer to 4-9-5 Troubleshooting.

If both the ERROR and RUN indicators are lit, check whether the operation mode switch on the back of the Analog I/O Unit is set correctly.

4-9-2 Errors Detected by Analog I/O Unit

When an error occurs at the Analog I/O Unit, the ERROR indicator on the front panel of the Unit lights and the error code is stored in bits 08 to 15 of IR word n+9.

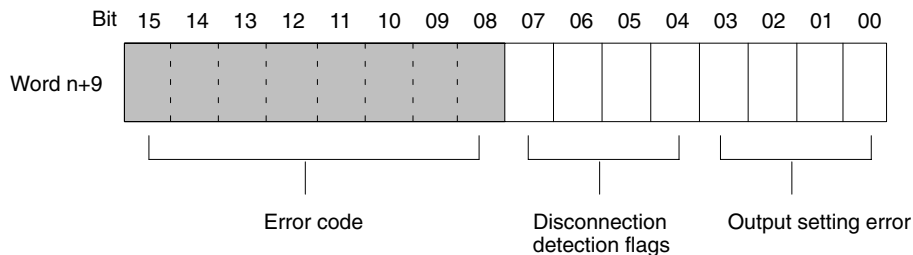

For the IR word addresses, $n = 100 + 10 \times \text{unit number}$.
 For Units #A to #F (10 to 15), $n = 400 + 10 \times (\text{unit number} - 10)$.

Error code		Error contents	Countermeasure
8	0	In adjustment mode, offset or gain cannot be adjusted because input value is out of the permissible range for adjustment.	If making the adjustment by means of a connected input device, first adjust the input device before adjusting the Analog Input Unit.
8	1	In adjustment mode, adjustment cannot be performed because the specified I/O number is not set for use or because the wrong input or output number is specified.	Check whether the word n I/O number to be adjusted is set to 21, 22, 11, or 12. Check whether the input or output number to be adjusted is set for use by means of the DM setting.
8	2	A disconnection was detected. (See note.)	Check the rightmost byte of IR word n+9. The inputs for bits that are ON may be disconnected. Restore any disconnected inputs.
8	3	The output setting range has been exceeded.	Correct the set value.
8	8	An EEPROM writing error has occurred while in adjustment mode.	Turn the Set Bit OFF, ON, and OFF again. If the error persists even after the reset, replace the Analog I/O Unit.
F	0	The specified I/O number is not set for use. (The loop-specified number.)	Set the I/O number for use.
F	1	A number outside of the 0 to 9999 BCD range has been specified for the ratio set value.	Specify a number from 0 to 9999 BCD.
F	2	The wrong output status for when conversion is stopped has been specified.	Specify a number from 0000 to 0002.
F	3	The wrong number of samplings has been specified for mean processing.	Specify a number from 0000 to 0004.

Note Disconnection detection (82) operates for input numbers used with a range of 1 V to 5 V (4 mA to 20 mA).
 Errors indicated with 8□ codes are automatically reset when proper countermeasures are taken. The errors indicated with F□ codes are cleared when the power is turned on after making the correct settings and when the Special I/O Unit Restart Bit is turned OFF, ON, and OFF again.

4-9-3 Errors Detected by CPU Unit

When the CPU Unit detects an error at a Special I/O Unit, it outputs to the CPU Unit's SR and AR areas as shown below.

Special I/O Unit Error Flag

Bit	Error	Contents	CPU Unit status	LED indicators
25415	I/O UNIT OVER	The same unit number has been set for more than one Special I/O Unit.	CPU Unit operation is stopped.	RUN: Not lit ERROR: Not lit
	SPECIAL I/O UNIT ERROR	Error occurred in I/O refresh between Special I/O Unit and CPU Unit.	Operation is stopped only for faulty Unit.	RUN: Not lit ERROR: Not lit

Special I/O Unit Error Flags

Bits		Functions	
C200HX/HG/HE			
	C200H/HS		
28200	AR 0000	Unit #0 Error Flag	Turns ON for any unit number when I/O UNIT OVER or SPECIAL I/O UNIT ERROR occurs.
28201	AR 0001	Unit #1 Error Flag	
28202	AR 0002	Unit #2 Error Flag	
28203	AR 0003	Unit #3 Error Flag	
28204	AR 0004	Unit #4 Error Flag	
28205	AR 0005	Unit #5 Error Flag	
28206	AR 0006	Unit #6 Error Flag	
28207	AR 0007	Unit #7 Error Flag	
28208	AR 0008	Unit #8 Error Flag	
28209	AR 0009	Unit #9 Error Flag	
28210 (See note.)	---	Unit #A Error Flag	
28211 (See note.)	---	Unit #B Error Flag	
28212 (See note.)	---	Unit #C Error Flag	
28213 (See note.)	---	Unit #D Error Flag	
28214 (See note.)	---	Unit #E Error Flag	
28215 (See note.)	---	Unit #F Error Flag	

Note SR bits 28210 to 28215 cannot be used with C200HE and C200HX/HG-CPU3□-E/4□-E PCs.

4-9-4 Restarting Special I/O Units

There are two ways to restart Special I/O Unit operation after having changed DM contents or having corrected the cause of an error. The first way is to power up the PC again, and the second way is to turn the Special I/O Unit Restart Bit ON and then OFF again.

Special I/O Unit Restart Bits

Bits		Functions	
C200HX/HG/HE			
	C200H/HS		
28100	AR 0100	Unit #0 Restart Bit	Turning the Restart Bit for any Unit ON and then OFF again restarts that Unit.
28101	AR 0101	Unit #1 Restart Bit	
28102	AR 0102	Unit #2 Restart Bit	
28103	AR 0103	Unit #3 Restart Bit	
28104	AR 0104	Unit #4 Restart Bit	
28105	AR 0105	Unit #5 Restart Bit	
28106	AR 0106	Unit #6 Restart Bit	
28107	AR 0107	Unit #7 Restart Bit	
28108	AR 0108	Unit #8 Restart Bit	
28109	AR 0109	Unit #9 Restart Bit	
28110 (See note.)	---	Unit #A Restart Bit	
28111 (See note.)	---	Unit #B Restart Bit	
28112 (See note.)	---	Unit #C Restart Bit	
28113 (See note.)	---	Unit #D Restart Bit	
28114 (See note.)	---	Unit #E Restart Bit	
28115 (See note.)	---	Unit #F Restart Bit	

Note SR bits 28210 to 28215 cannot be used with C200HE and C200HX/HG-CPU3□-E/4□-E PCs.

If the error is not cleared even after turning the Special I/O Unit Restart Bit ON and then OFF again, then replace the Unit.

4-9-5 Troubleshooting

The following tables explain the probable causes of troubles that may occur, and the countermeasures for dealing with them.

Conversion Data Does Not Change

Probable cause	Countermeasure	Page
The input is not set for being used.	Set the input to be used.	81
The peak value function is in operation.	Turn off the peak value function if it is not required.	84
The input device is not working, the input wiring is wrong, or there is a disconnection.	Using a tester, check to see if the input voltage or current is changing.	74
	Use Unit's error codes to check for a disconnection.	85, 105

Value Does Not Change as Intended

Probable cause	Countermeasure	Page
The input device's signal range does not match the input signal range for the relevant input number at the Analog Input Unit.	Check the specifications of the input device, and match the settings for the input signal ranges.	81
The offset and gain are not adjusted.	Adjust the offset and gain.	92
When using the 4 mA to 20 mA range, the voltage input (+) terminal and the current input (+) terminal are not connected.	Connect the terminals.	74
The ratio conversion function is set to be used, so the calculation results are being monitored.	Correct the conversion settings.	89

Conversion Values are Inconsistent

Probable cause	Countermeasure	Page
The input signals are being affected by external noise.	Change the shielded cable connection to the Unit's COM terminal.	74
	Insert a 0.01- μ F to 0.1- μ F ceramic capacitor or film capacitor between the input's (+) and (-) terminals.	---
	Try increasing the number of mean value processing buffers.	82

Analog Output Does Not Change

Probable Cause	Countermeasure	Page
The output is not set for being used.	Set the output for being used.	86
The output hold function is in operation.	Turn ON the Output Conversion Enable Bit.	87
The conversion value is set outside of the permissible range.	Set the data within the range.	68

Output Does Not Change as Intended

Probable Cause	Countermeasure	Page
The output signal range setting is wrong.	Correct the output signal range setting.	86
The I/O specifications of the output device do not match those of the Analog Output Unit (e.g., input signal range, input impedance).	Change the output device.	66
The offset or gain is not adjusted.	Adjust the offset or gain.	97
The ratio conversion function is set to be used.	Correct the conversion settings.	89

Outputs are Inconsistent

Probable Cause	Countermeasure	Page
The output signals are being affected by external noise.	Try changing the shielded cable connection (e.g., the grounding at the output device).	74

Appendix A

Dimensions

External Dimensions

Unit: mm

- C200H-AD003**
- C200H-DA003**
- C200H-DA004**
- C200H-MAD01**

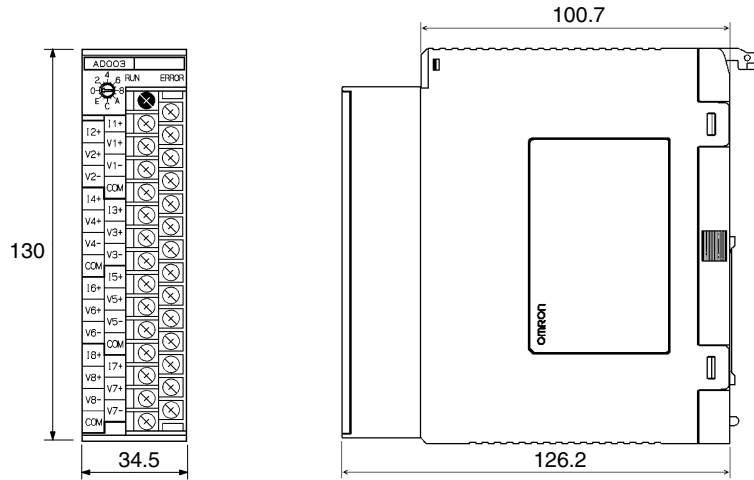

Appendix B

Changes From Earlier Models

Differences Between C200H-AD003 and C200H-AD001/AD002

Functions

Conversion Permission Setting

With the C200H-AD003, in contrast to the C200H-AD001/002, use designation inputs must be set in advance to “1: Use.”

A/D Conversion Data Identification Setting

Only the C200H-AD002 has this function; the C200H-AD003 does not. Data is always output in 16-bit binary, and a BCD display can be created using a ladder program. (Refer to page 118, *Sample Program 6: Binary-to-BCD Conversion*.)

Square Root Calculation Function

The C200H-AD003 does not have this function, but an equivalent can be created using a ladder program. (Refer to page 119, *Sample Program 7: Square Root Calculation*.)

Scaling Function

The C200H-AD003 does not have this function, but an equivalent can be created using a ladder program. (Refer to page 116, *Sample Program 5: Scaling Function*.)

Mean Value Processing Function

With C200H-AD001/002 mean values, digital output values were not refreshed until the data was obtained from the set number of samplings. With the C200H-AD003, however, the digital output values are refreshed with each conversion cycle. (For details regarding C200H-AD003 mean value processing, refer to *2-5-3 Mean Value Processing*.) A function equivalent to the mean value processing of the C200H-AD001/002 can be created using a ladder program. (Refer to page 120, *Sample Program 8: Mean Value Processing*.)

Upper- and Lower-limit Alarm Function

Only the C200H-AD002 has this function; the C200H-AD003 does not. An equivalent can be created using a ladder program. (Refer to page 114, *Sample Program 3: Upper- and Lower-limit Alarm (Regular Monitoring)* and *Sample Program 4: Upper- and Lower-limit Alarm (With Sequence)*.)

Offset and Gain Adjustment Functions

These functions have been provided for the C200H-AD003. (Refer to *2-6 Offset and Gain Adjustment*.)

Input Range

The voltage and current can be converted for up to $\pm 5\%$ of the full input range.

Analog Input Values

The following table shows the analog input values. Digital conversion values are shown as 16-bit binary data.

Input signal range	AD003	AD002	AD001
-10.0 to 10.0 V	F830 to 07D0 (-11.0 to 11.0 V: F768 to 0898)	87D0 to 07D0	---
0 to 10 V	0000 to 0FA0 (-0.5 to 10.5 V: FF38 to 1068)	0000 to 0FA0	0000 to 0FA0
1 to 5 V / 4 to 20 mA	0000 to 0FA0 (0.8 to 5.2 V / 3.2 to 20.8 mA: FF38 to 1068)	0000 to 0FA0	0000 to 0FA0

Note The figures shown in parentheses are full-scale $\pm 5\%$.

Error Codes

Error codes have been provided for the C200H-AD003. DM area setting errors and errors during operation are stored in the IR area when the ERR indicator lights. (Refer to *2-7-2 Errors Detected by Analog Input Unit.*)

BROKEN WIRE Indicator

The C200H-AD003 does not have a BROKEN WIRE indicator. It uses the ERR indicator, error code, and Disconnection Detection Flag to indicate a disconnection in the input wiring. Notification of disconnections can only be used with an input range of 1 to 5 V or 4 to 20 mA.

Differences Between C200H-DA003/004 and C200H-DA001/002

Functions

Conversion Permission Setting

With the C200H-DA003/004, in contrast to the C200H-DA001/002, use designation outputs must be set in advance to “1: Use.”

Output Hold Function

This function has been provided for the C200H-DA003/004. (Refer to *3-5-2 Output Hold Function.*)

Offset and Gain Adjustment Functions

These functions have been provided for the C200H-DA003/004. (Refer to *3-6 Offset and Gain Adjustment.*)

Output Range

The voltage and current can be converted for up to $\pm 5\%$ of the full output range.

Analog Output Values

The following table shows the analog output values. Digital set values are shown as 16-bit binary data.

Input signal range	DA003	DA002	DA001
-10.0 to 10.0 V	F830 to 07D0 (-11.0 to 11.0 V: F768 to 0898)	8FFF to 0FFF	---
0 to 10 V	0000 to 0FA0 (-0.5 to 10.5 V: FF38 to 1068)	0000 to 0FFF	0000 to 0FFF
1 to 5 V / 4 to 20 mA	0000 to 0FA0 (0.8 to 5.2 V / 3.2 to 20.8 mA: FF38 to 1068)	0000 to 0FFF	0000 to 0FFF

Note The figures shown in parentheses are full-scale $\pm 5\%$.

Error Codes

Error codes have been provided for the C200H-DA003/004. DM area setting errors and errors during operation are stored in the IR area when the ERR indicator lights. (Refer to *3-7-2 Errors Detected by Analog Output Unit.*)

Appendix C

Sample Programs

Sample Program 1: Obtaining Analog Input Unit Conversion Values

This is a program for obtaining the Analog Input Unit's conversion values. Individual input values are obtained by MOV(21) when their Disconnection Detection Flags turn OFF. (With the C200H-AD003, there are no causes for errors in normal mode other than disconnections, so a disconnection can be determined merely by seeing that bit 15 of word 109 is ON.)

Unit Settings

Item	Setting contents	Actual settings
Unit	C200H-AD003	---
Unit number	#0	Unit number switch: 0
Operation mode	Normal mode	Back-panel DIP switch: All OFF
Inputs 1 to 8 used	---	DM 1000 = 00FF
Input signal range	All input numbers, 1 to 5 V	DM 1001 = AAAA

Program Example

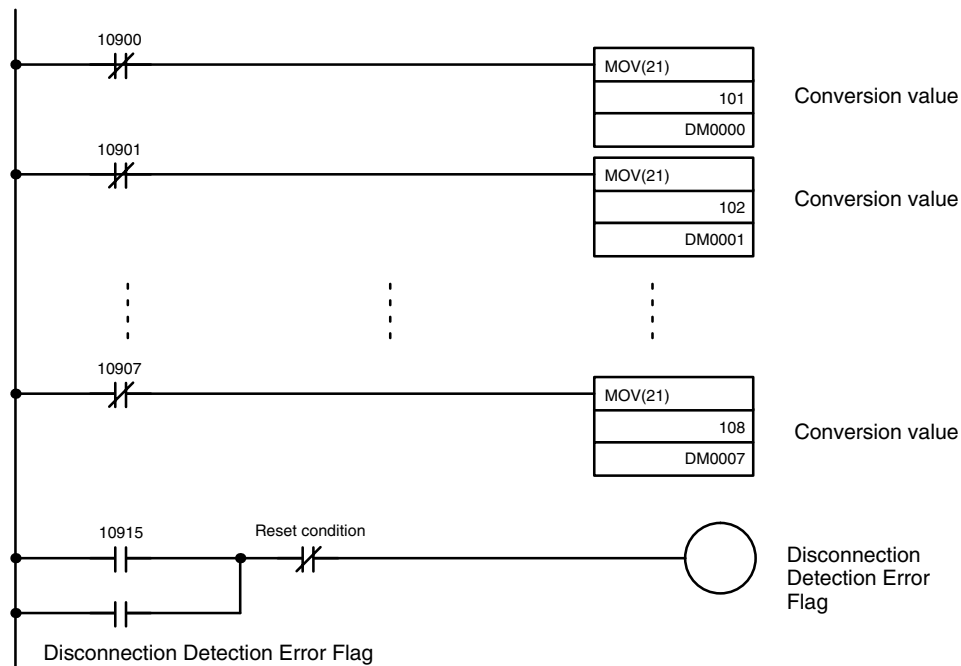

Sample Program 2: Writing Analog Output Unit Set Values

This is a program for writing Analog Output Unit set values. (With the C200H-DA003/DA004, there are no causes for errors in normal mode other than output setting errors, so an output setting error can be determined merely by seeing that bit 15 of word 109 is ON.)

Unit Settings

Item	Setting contents	Actual settings
Unit	C200H-DA003	---
Unit number	#0	Unit number switch: 0
Operation mode	Normal mode	Back-panel DIP switch: All OFF
Output 1 used	---	DM 1000 = 0001
Output signal range	Output number 1, 0 to 10 V	DM 1001 = 0001

Program Example

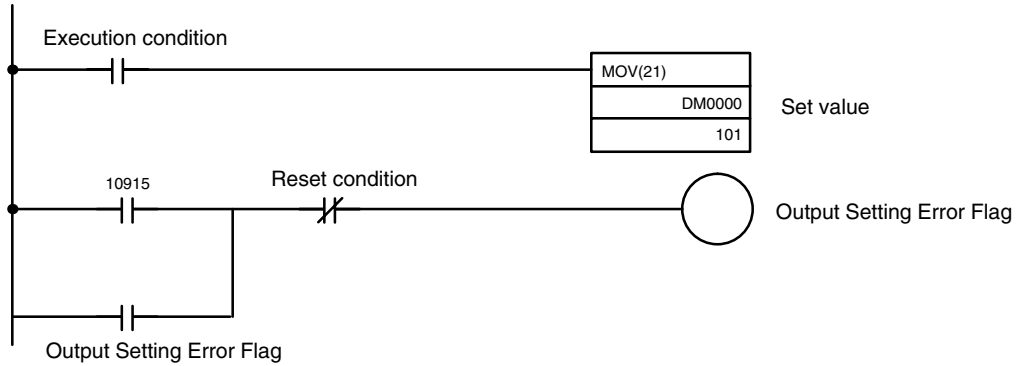

Sample Program 3: Upper- and Lower-limit Alarm (Regular Monitoring)

Comparisons are made to the upper and lower limits of the A/D conversion values or D/A output values from the beginning of operation. If they fall outside the specified range, the Alarm Flag will turn ON.

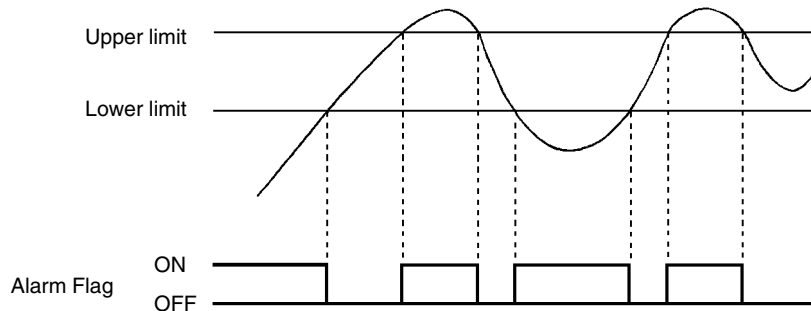

Unit Settings

When using the upper- or lower-limit alarm for input conversion values:

Item	Setting contents	Actual settings
Unit	C200H-AD003	---
Unit number	#0	Unit number switch: 0
Operation mode	Normal mode	Back-panel DIP switch: All OFF
Input 1 used	---	DM 1000 = 0001
Input signal range	Input number 1, 0 to 10 V	DM 1001 = 0001

When using the upper- or lower-limit alarm for output set values:

Item	Setting contents	Actual settings
Unit	C200H-DA003	---
Unit number	#0	Unit number switch: 0
Operation mode	Normal mode	Back-panel DIP switch: All OFF
Output 1 used	---	DM 1000 = 0001
Output signal range	Output number 1, 0 to 10 V	DM 1001 = 0001

Program Example

The following program can be executed only with the C200HS, C200HX/HG/HE CPU Units.

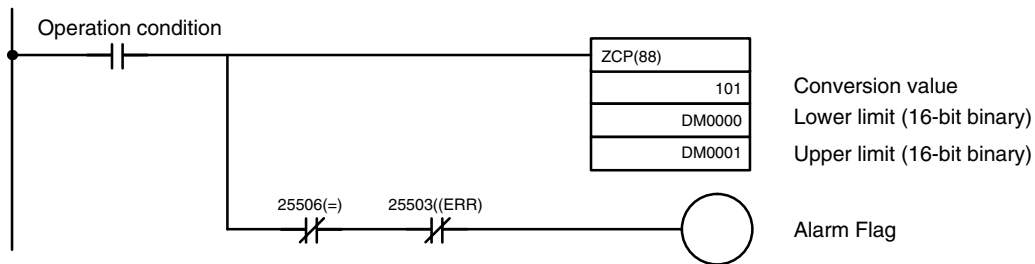

Sample Program 4: Upper- and Lower-limit Alarm (With Sequence)

Comparisons are made to the upper and lower limits of the A/D conversion values or D/A output values after the value falls within the range between the upper limit and lower limit following the beginning of operation. If they fall outside the specified range, the Alarm Flag will turn ON.

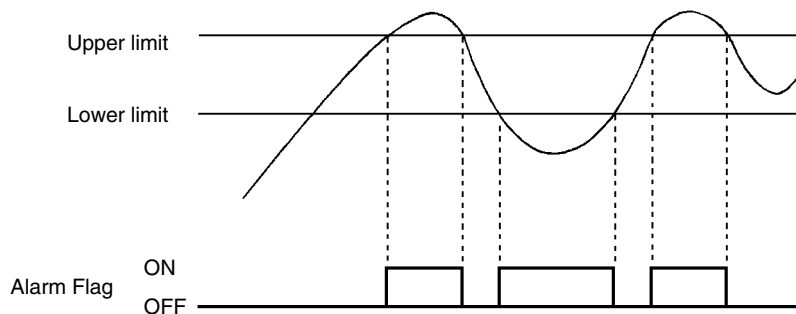

Unit Settings

Item	Setting contents	Actual settings
Unit	C200H-AD003	---
Unit number	#0	Unit number switch: 0
Operation mode	Normal mode	Back-panel DIP switch: All OFF
Input 1 used	---	DM 1000 = 0001
Input signal range	Input number 1, 0 to 10 V	DM 1001 = 0001

Program Example

The following program can be executed only with the C200HS, C200HX/HG/HE CPU Units.

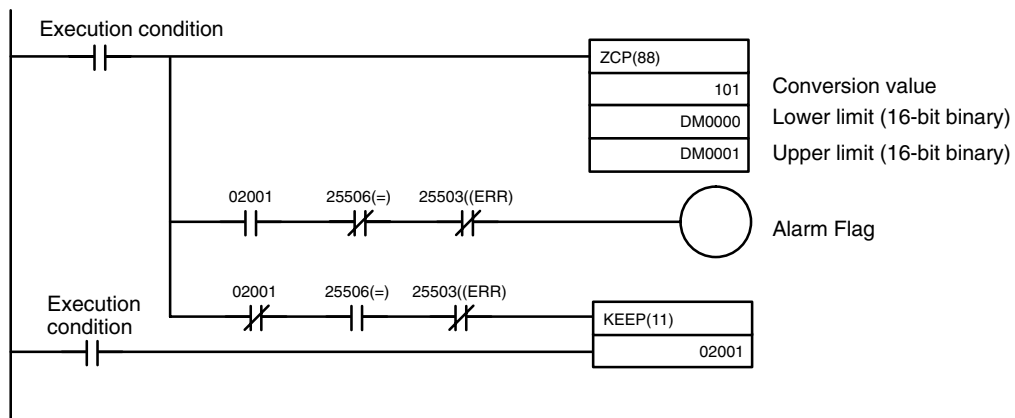

Sample Program 5: Scaling

A/D conversion values are converted into BCD data whose full scale is set by the lower-limit value data and upper-limit value data and retrieved as scaling data. The DM 0000 value will vary depending on the input signal range of the input number subject to scaling.

Unit Settings

Item	Setting contents	Actual settings
Unit	C200H-AD003	---
Unit number	#0	Unit number switch: 0
Operation mode	Normal mode	Back-panel DIP switch: All OFF
Input 1 used	---	DM 1000 = 0001

Program Example

The following program can be executed only with the C200HS, C200HX/HG/HE CPU Units.

- Data Flow (Unit Number 0): Word 101 → Word 200 (scaling result)

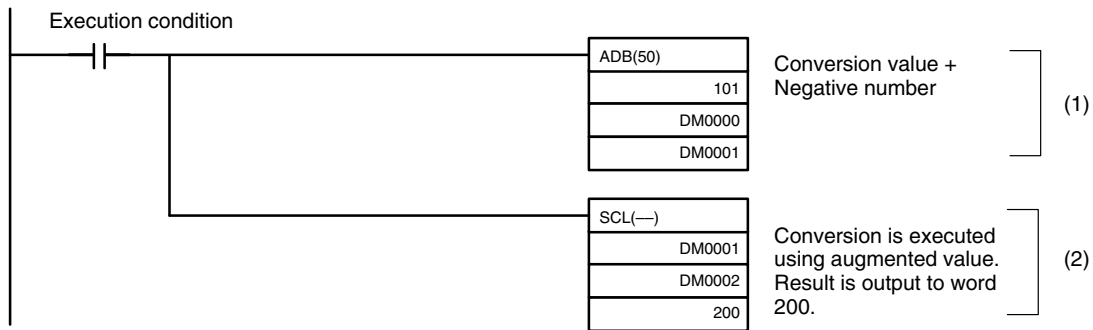

- 1, 2, 3...**
1. Negative numbers cannot be used as conversion values with the SCL instruction, so the negative portion (0 V–5%, 1 V–5%, 4 mA–5%) is augmented.
 2. The lower limit (FF38) to upper limit (1068) range is scaled to a range of 0 to 4400 BCD, and output to word 200.

DM Area Setting Value for All Input Signal Ranges

Input Signal Range: 0 to 10 V / 1 to 5 V / 4 to 20 mA

The following shows a case where conversion data (full-scale) for the input signal range of 0 to 10 V is scaled to a range of 0 to 4400 BCD.

- Data Flow (0 to 10 V range)

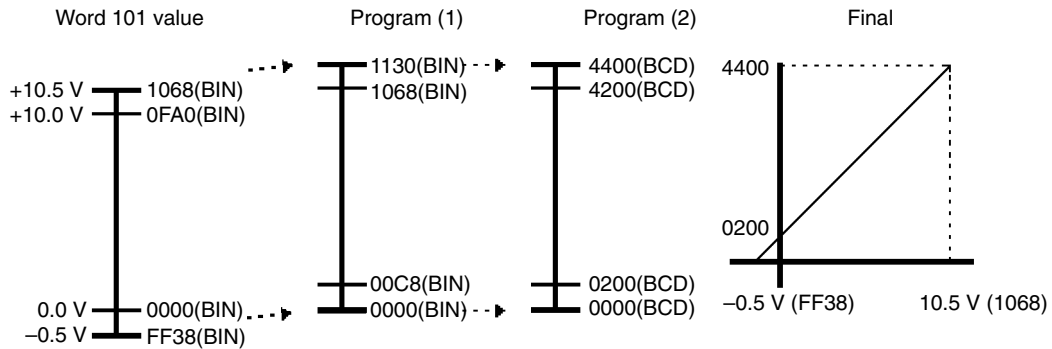

• DM Area Setting

DM0000: 00C8	Digital value for -5%	
DM0001: (Used for calculation)	Conversion value +C8 (-5% portion)	
DM0002: 0000	Lower limit: BCD	
DM0003: 0000	Lower limit +C8 (-5% portion): BIN	Used with SCL instruction
DM0004: 4400	Upper limit: BCD	
DM0005: 1130	Upper limit +C8 (+5% portion): BIN	

Input Signal Range: -10 to 10 V

The following shows a case where conversion data (full-scale) for the input signal range of -10 to 10 V is scaled to a range of 0 to 4400 BCD.

• Data Flow (-10 to 10 V range)

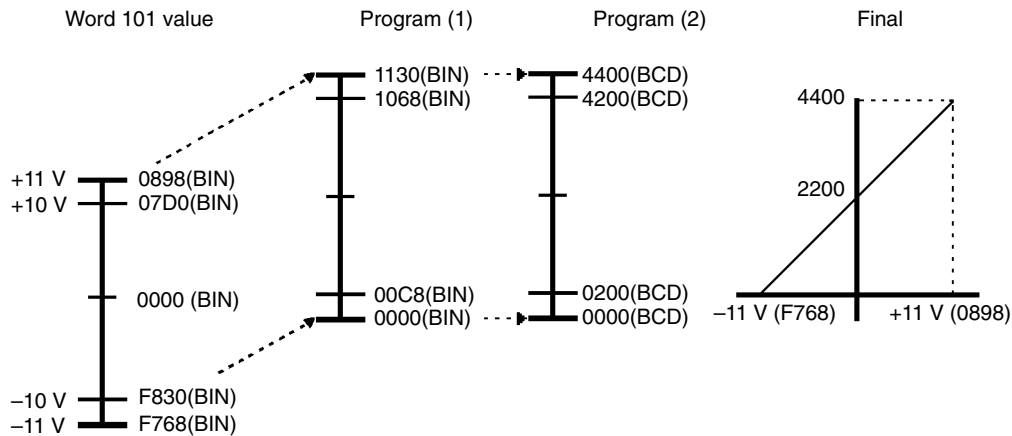

• DM Area Settings for a Signal Range of -10 to 10 V

DM0000: 0898	Digital value for -5%	
DM0001: (Used for calculation)	Conversion value +0898 (-5% portion)	
DM0002: 0000	Lower limit: BCD	
DM0003: 0000	Lower limit +0898 (-5% portion): BIN	Used with SCL instruction
DM0004: 4400	Upper limit: BCD	
DM0005: 1130	Upper limit +0898 (-5% portion): BIN	

Note The following shows a case where conversion data (full-scale) for the input range of 0 to 10 V is scaled to a range of 100 to 500 BCD.

• Data Flow (0 to 10 V range)

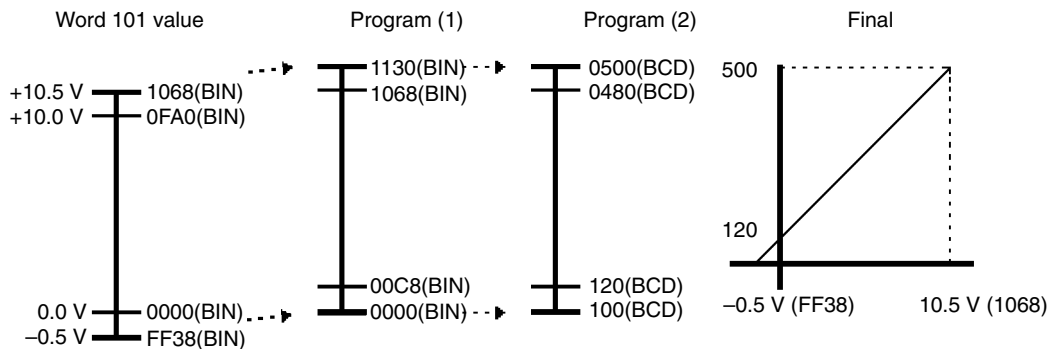

• DM Area Setting

DM0000: 00C8	Digital value for -5%	} Used with SCL instruction
DM0001: (Used for calculation)	Conversion value +C8 (-5% portion)	
DM0002: 0100	Lower limit: BCD	
DM0003: 0000	Lower limit +C8 (-5% portion): BIN	
DM0004: 0500	Upper limit: BCD	
DM0005: 1130	Upper limit +C8 (-5% portion): BIN	

Sample Program 6: Binary-to-BCD Conversion

A/D conversion values (16-bit binary data) are converted into signed BCD data. The “signed BCD” data refers to BCD data that is indicated by 7-digit data and 1-digit sign (0: +; F: -).

• Conversion Graph (Horizontal Axis: Input Voltage, Vertical Axis: BCD Data)

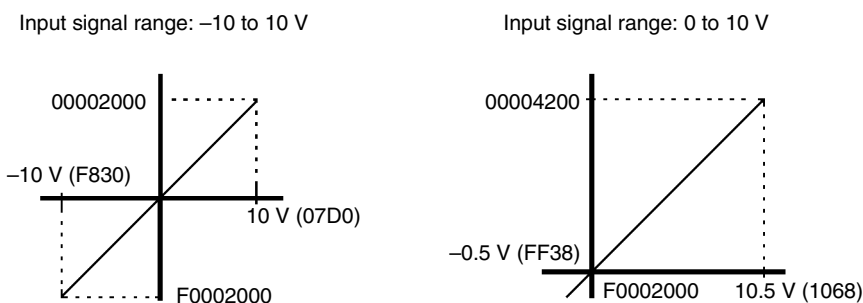

Unit Settings

Item	Setting contents	Actual settings
Unit	C200H-AD003	---
Unit number	#0	Unit number switch: 0
Operation mode	Normal mode	Back-panel DIP switch: All OFF
Input 1 used	---	DM 1000 = 0001
Input signal range	Input number 1, 0 to 10 V	DM 1001 = 0001

Program Example

The following program can be executed only with the C200HS, C200HX/HG/HE CPU Units.

- Data Flow (Unit Number 0):
Word 101 (AD Conversion Value) → Words 201 and 202 (Conversion Results)

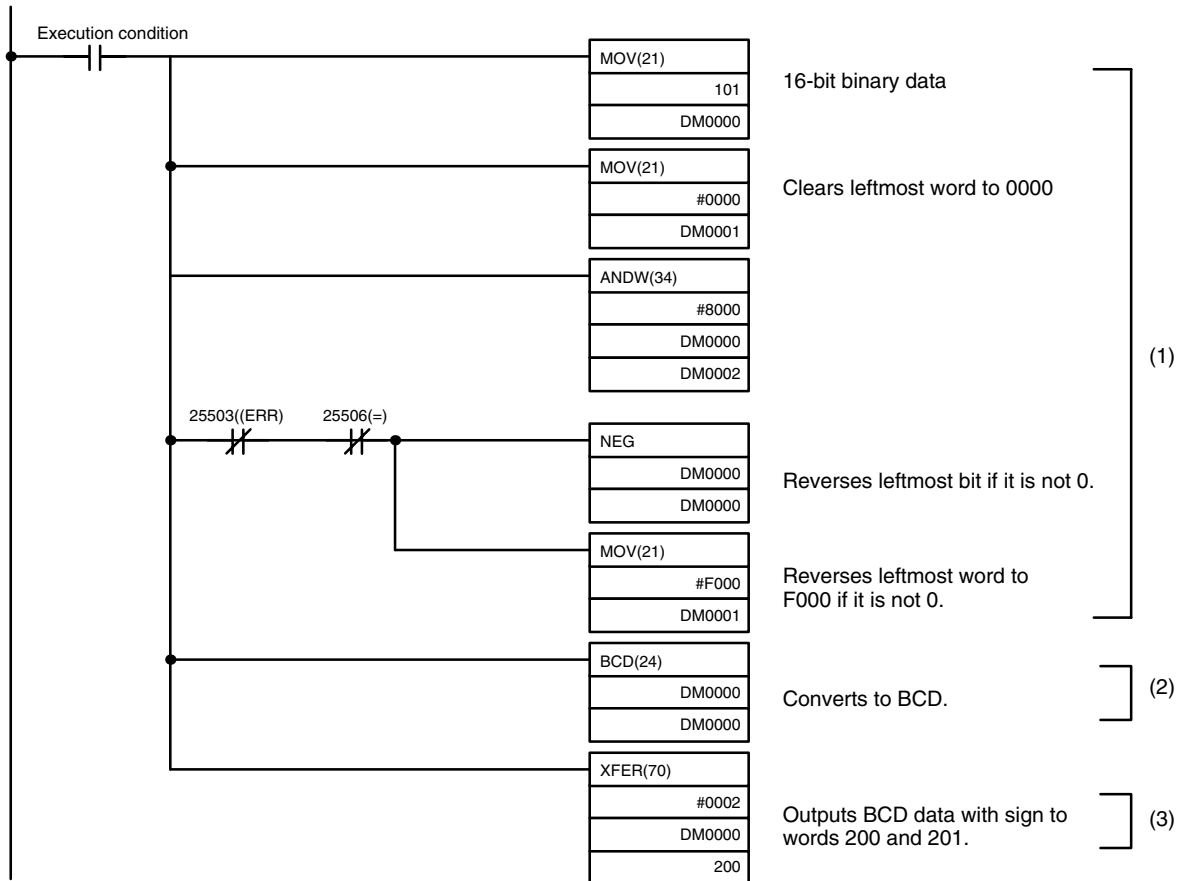

- 1, 2, 3...**
1. If the leftmost bit is a 1 (negative number) in 16-bit binary data, the data is reversed.
 2. 16-bit binary data is converted to BCD.
 3. BCD data with sign is output to words 200 and 201.

Sample Program 7: Square Root Calculation

Data expressed as quadratic curves, such as thermocouple inputs, is converted and output to linear data (0000 to 4400).

Unit Settings

Item	Setting contents	Actual settings
Unit	C200H-AD003	---
Unit number	#0	Unit number switch: 0
Operation mode	Normal mode	Back-panel DIP switch: All OFF
Input 1 used	---	DM 1000 = 0001
Input signal range	Input number 1, 0 to 10 V	DM 1001 = 0001

Program Example

The following program can be executed only with the C200HS, C200HX/HG/HE CPU Units.

- Data Flow (Unit Number 0): Word 101 (AD Conversion Value) → Word 200 (Calculation Result)

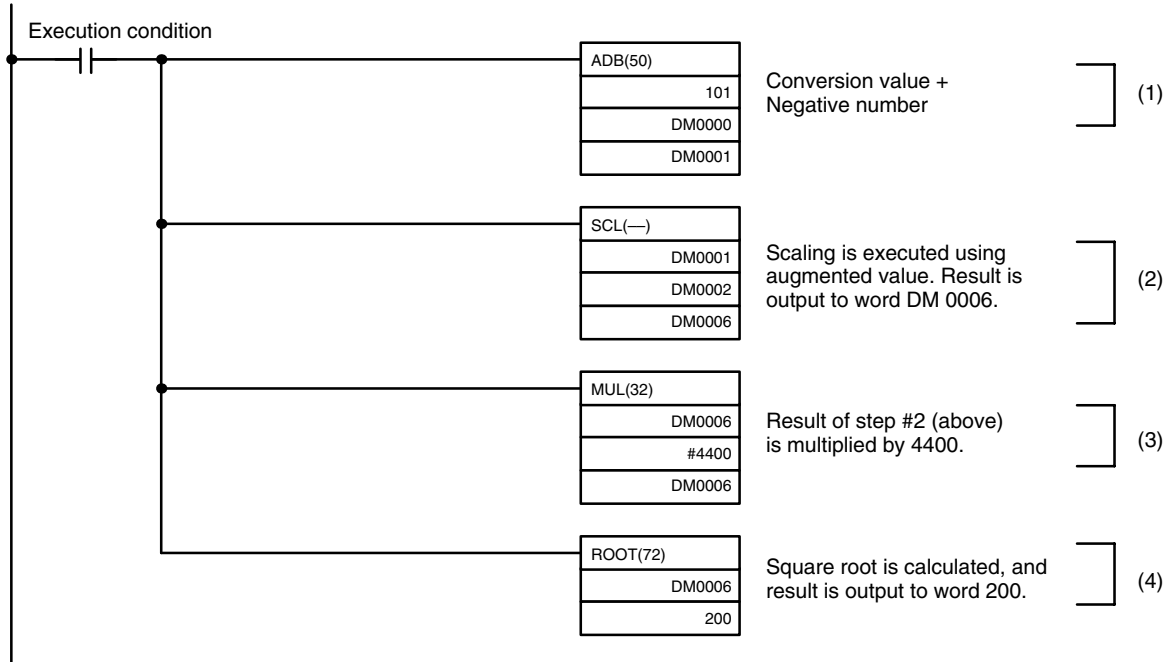

- 1, 2, 3...**
1. The negative number portion is added to the conversion value (word 101).
 2. The binary data is scaled to a range of 0 to 4400.
 3. The scaling results are multiplied by 4400.
 4. The square root is calculated, and the result is output to word 200.

DM Area Settings

Input signal range: 0 to 10 V / 1 to 5 V / 4 to 20 mA

DM0000: 00C8	Digital value for -5%	
DM0001: (Used for calculation)	Conversion value +C8 (-5% portion)	
DM0002: 0000	Lower limit: BCD	
DM0003: 0000	Lower limit +C8 (-5% portion): BIN	Used with SCL instruction
DM0004: 4400	Upper limit: BCD	
DM0005: 1130	Upper limit +C8 (-5% portion): BIN	
DM0006: (Used for calculation)		

If the result of the binary-to-BCD conversion is negative, an error will be generated by the ROOT(72) instruction. With a signal range of -10 to 10 V, scaling is executed by augmenting the negative portion (-10 V-5%). In this program example, the value of DM 0000 is converted to 0898. Refer to page 116.

Sample Program 8: Mean Value Processing

Data is taken for the set number of samplings and the mean value is calculated.

Unit Settings

Item	Setting contents	Actual settings
Unit	C200H-AD003	---
Unit number	#0	Unit number switch: 0
Operation mode	Normal mode	Back-panel DIP switch: All OFF
Input 1 used	---	DM 1000 = 0001
Input signal range	Input number 1, 0 to 10 V	DM 1001 = 0001

Program Example

The following program can be executed only with the C200HS, C200HX/HG/HE CPU Units.

- Data Flow (Unit Number 0): Word 101 (AD Conversion Value) → DM 0001 (Mean Value Result)

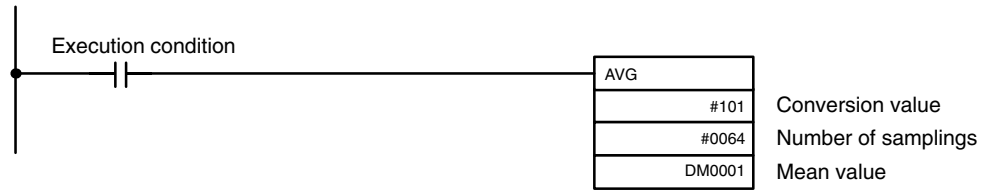

The number of samplings will be no more than 64 when the AVG instruction is used.

Sample Program 9: Peak Value Holding

This is a program for Analog Output Unit peak value holding. If the output value range is exceeded, the output voltage or current is held when the Conversion Enable Bit turns OFF.

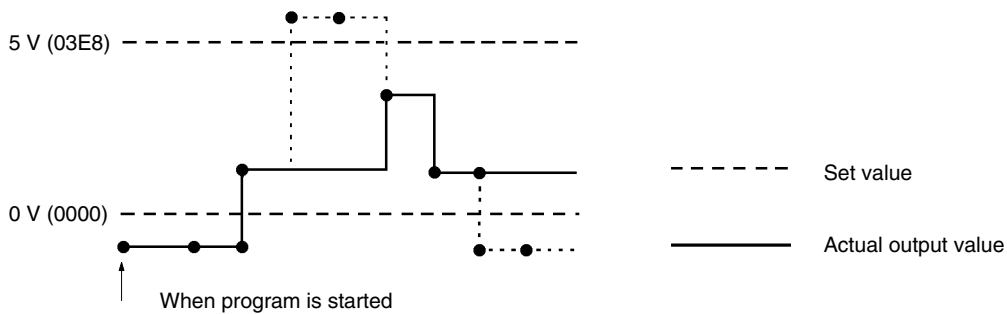

Unit Settings

Item	Setting contents	Actual settings
Unit	C200H-DA003	---
Unit number	#0	Unit number switch: 0
Operation mode	Normal mode	Back-panel DIP switch: All OFF
Output 1 used	---	DM 1000 = 0001
Output signal range	All output numbers, -10 to 10 V	DM 1001 = 0000
Output hold function	HOLD	DM 1002 = 0001

Program Example

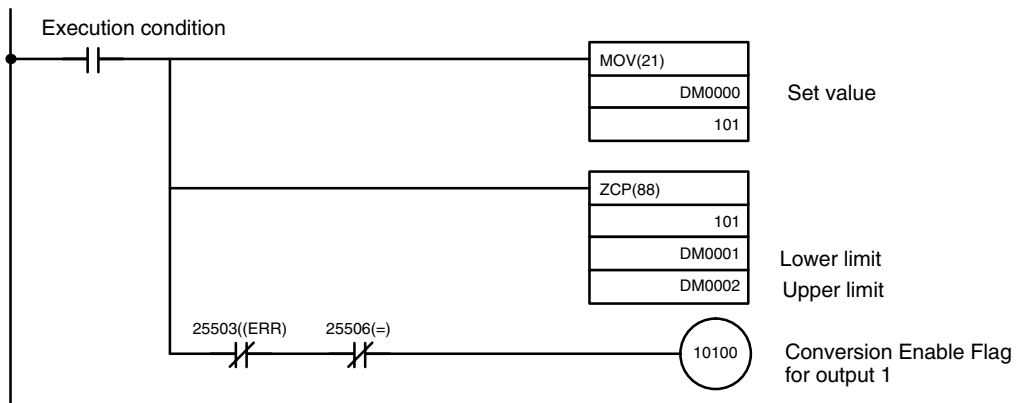

DM Area Settings

DM0001: 0000	Lower limit: 0 V
DM0002: 03E8	Upper limit: 5 V

Appendix D

Data Memory Coding Sheet

C200H-AD003

DM word	Setting contents			
	15	8	7	0
DM □□00				
DM □□01				
DM □□02				
DM □□03				
DM □□04				
DM □□05				
DM □□06				
DM □□07				
DM □□08				
DM □□09				

DM word	Setting contents			
	15	8	7	0
m	Use designation			
m+1	Input signal range setting			
m+2	Input 1: Mean value processing setting			
m+3	Input 2: Mean value processing setting			
m+4	Input 3: Mean value processing setting			
m+5	Input 4: Mean value processing setting			
m+6	Input 5: Mean value processing setting			
m+7	Input 6: Mean value processing setting			
m+8	Input 7: Mean value processing setting			
m+9	Input 8: Mean value processing setting			

Use Designation

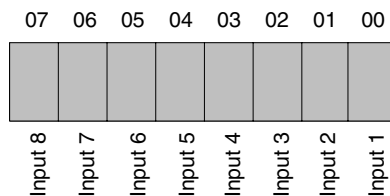

0: Do not use.
1: Use.

Input Signal Range Setting

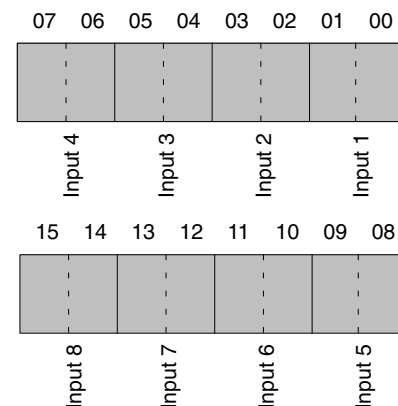

00: -10 to 10 V
01: 0 to 10 V
10: 1 to 5 V / 4 to 20 mA
11: Same as 10 above

Mean Value Processing Setting

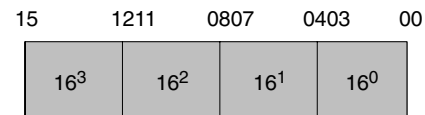

0000: No mean value processing
0001: Use mean value processing with 2 buffers.
0002: Use mean value processing with 4 buffers.
0003: Use mean value processing with 8 buffers.
0004: Use mean value processing with 16 buffers.

C200H-DA003/DA004

DM word	Setting contents			
	15	8	7	0
DM □□00				
DM □□01				
DM □□02				
DM □□03				
DM □□04				
DM □□05				
DM □□06				
DM □□07				
DM □□08				
DM □□09				

DM word	Setting contents			
	15	8	7	0
m	Use designation			
m+1	Output signal range setting			
m+2	Output 1: Output status when conversion stopped			
m+3	Output 2: Output status when conversion stopped			
m+4	Output 3: Output status when conversion stopped			
m+5	Output 4: Output status when conversion stopped			
m+6	Output 5: Output status when conversion stopped			
m+7	Output 6: Output status when conversion stopped			
m+8	Output 7: Output status when conversion stopped			
m+9	Output 8: Output status when conversion stopped			

Use Designation

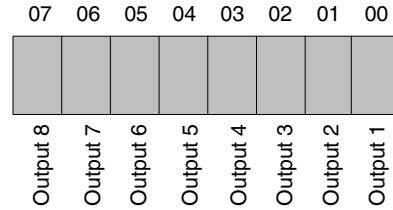

0: Do not use.
1: Use.

Signal Range Setting (Not Valid for C200H-DA004)

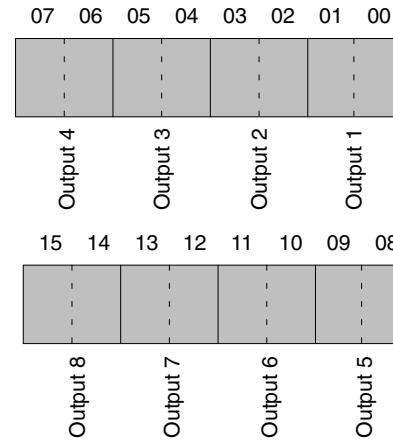

00: -10 to 10 V
01: 0 to 10 V
10: 1 to 5 V / 4 to 20 mA
11: Same as 10 above

Output Status When Conversion Stopped

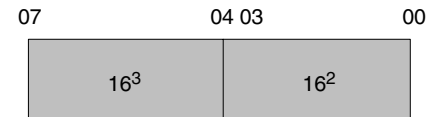

00: CLR (0 output)
01: HOLD (Hold prior output value.)
02: MAX (Output maximum value of range.)

C200H-MAD01

DM word	Setting contents			
	15	8	7	0
DM □□00				
DM □□01				
DM □□02				
DM □□03				
DM □□04				
DM □□05				
DM □□06				
DM □□07				
DM □□08				
DM □□09				
DM □□10				
DM □□11				
DM □□12				
DM □□13				

DM word	Setting contents			
	15	8	7	0
m		Loop use designation	Input use designation	Output use designation
m+1		Input signal range setting		Output signal range setting
m+2			Output 1: Output status when conversion stopped	
m+3			Output 2: Output status when conversion stopped	
m+4				
m+5				
m+6	Input 1: Mean value processing setting			
m+7	Input 2: Mean value processing setting			
m+8				
m+9				
m+10	Loop 1 (input 1 → output 1), A constant			
m+11	Loop 1 (input 1 → output 1), B constant			
m+12	Loop 2 (input 2 → output 2), A constant			
m+13	Loop 2 (input 2 → output 2), B constant			

A Constant
0 to 9999 BCD (0.00 to 99.99; unit: 0.01)

B Constant
16-bit binary data

Use Designation

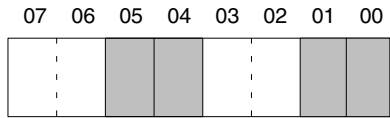

0: Do not use.
1: Use

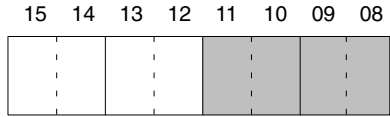

00: Do not use.
01: Positive gradient conversion
10: Negative gradient conversion
11: Do not use.

Signal Range Setting

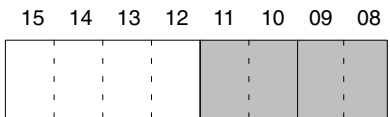
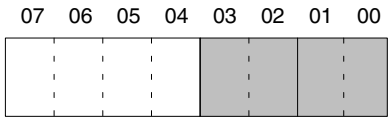

00: -10 to 10 V
01: 0 to 10 V
10: 1 to 5 V / 4 to 20 mA
11: Same as 10 above

Output Status When Conversion Stopped

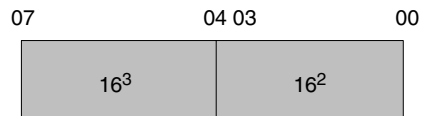

00: CLR (0 output)
01: HOLD (Hold prior output value.)
02: MAX (Output maximum value of range.)

Mean Value Processing Setting

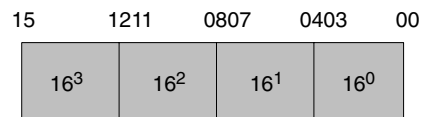

0000: No mean value processing
0001: Use mean value processing with 2 buffers.
0002: Use mean value processing with 4 buffers.
0003: Use mean value processing with 8 buffers.
0004: Use mean value processing with 16 buffers.

Index

A

- A constant, 91
 - C200H-MAD01, DM set value, 80
- adjustment mode
 - C200H-AD003, IR area allocation, 19
 - C200H-DA003, IR area allocation, 48
 - C200H-DA004, IR area allocation, 48
 - C200H-MAD01, IR area allocation, 78
- alarm, upper and lower limit, conversion program, 116

B

- B constant, 91
 - C200H-MAD01, DM set value, 80
- bias, 91
- binary to BCD, conversion program, 120

C

- circuits
 - C200H-AD003, 15
 - C200H-DA003, 43
 - C200H-DA004, 43
 - current output, C200H-MAD01, 73
 - input, C200H-MAD01, 72
 - voltage output, C200H-MAD01, 73
- Clear Bit
 - C200H-AD003, IR set value, 19
 - C200H-DA003, IR set value, 48
 - C200H-DA004, IR set value, 48
 - C200H-MAD01, IR set value, 78
- conversion programs
 - binary to BCD, 120
 - mean value processing, 122
 - scaling, 118
 - square root, 121
 - upper- and lower-limit alarm, 116
- conversion values
 - C200H-AD003
 - IR adjustment mode stored value, 19
 - IR normal mode stored value, 18
 - reading, 22
 - C200H-DA003, 52
 - IR adjustment mode stored value, 48
 - IR normal mode set value, 47
 - C200H-DA004, 52
 - IR adjustment mode stored value, 48
 - IR normal mode set value, 47
 - C200H-MAD01, 88
 - IR adjustment mode stored value, 78
 - IR normal mode set value for output, 77
 - IR normal mode stored value for input, 77
 - reading, 82

- CPU Unit, Special I/O Unit Error Flag
 - C200H-AD003, 34
 - C200H-DA003, 63
 - C200H-DA004, 63
 - C200H-MAD01, 107
- crimp-type terminals, torque
 - C200H-AD003, 16
 - C200H-DA003, 45
 - C200H-DA004, 45
 - C200H-MAD01, 75

D

- differences, from earlier models, 113
- dimensions, external, 111
- DM area, unit number setting, 7
 - C200H-AD003, 13
 - C200H-DA003, 41
 - C200H-DA004, 41
 - C200H-MAD01, 71
- DM area allocation
 - C200H-AD003, 20
 - set and stored values, 21
 - C200H-DA003, 49
 - set and stored values, 50
 - C200H-DA004, 49
 - set and stored values, 50
 - C200H-MAD01, 79
 - set and stored values, 80
- DM coding sheets
 - C200H-AD003, 124
 - C200H-DA003, 126
 - C200H-DA004, 126
 - C200H-MAD01, 128
- Down Bit
 - C200H-DA003, IR set value, 48
 - C200H-DA004, IR set value, 48
 - C200H-MAD01, IR set value, 78

E

- error codes
 - C200H-AD003, 33
 - IR adjustment mode stored value, 19
 - IR normal mode stored value, 18
 - C200H-DA003, 62
 - IR adjustment mode stored value, 48
 - IR normal mode stored value, 47
 - C200H-DA004, 62
 - IR adjustment mode stored value, 48
 - IR normal mode stored value, 47
 - C200H-MAD01, 106
 - IR adjustment mode stored value, 78
 - IR normal mode stored value, 77
- errors
 - C200H-DA003, setting, 47, 53
 - C200H-DA004, setting, 47, 53
 - C200H-MAD01, setting, 77, 89

F–G

- field devices, 4
- gain adjustment function, 3
 - bits used
 - C200H-AD003, 28
 - C200H-DA003, 55
 - C200H-DA004, 55
 - C200H-MAD01 for input, 93
 - C200H-MAD01 for output, 99
 - clearing
 - C200H-AD003, 32
 - C200H-DA003, 61
 - C200H-DA004, 61
 - C200H-MAD01 for input, 97
 - C200H-MAD01 for output, 104
 - input number specification
 - C200H-AD003, 28
 - C200H-MAD01, 93
 - output number specification
 - C200H-DA003, 55
 - C200H-DA004, 55
 - C200H-MAD01, 98
 - procedure, 8
 - C200H-AD003, 30
 - C200H-DA003, 58
 - C200H-DA004, 58
 - C200H-MAD01 for input, 96
 - C200H-MAD01 for output, 102
- Gain Bit
 - C200H-AD003, IR set value, 19
 - C200H-DA003, IR set value, 48
 - C200H-DA004, IR set value, 48
 - C200H-MAD01, IR set value, 78
- gradient conversion
 - negative, 90
 - positive, 90

H–I

- history buffers
 - C200H-AD003, 23
 - C200H-MAD01, 82
- indicators
 - C200H-AD003, 13
 - C200H-DA003, 41
 - C200H-DA004, 41
 - C200H-MAD01, 70
- input disconnection detection function, 2
 - C200H-AD003, 25
 - IR adjustment mode set value, 19
 - IR adjustment mode signal range, 19
 - IR normal mode signal range, 18
 - IR normal mode stored value, 18
 - C200H-MAD01, 85
 - IR adjustment mode set value, 78
 - IR adjustment mode signal range, 78
 - IR normal mode signal range, 77
 - IR normal mode stored value, 77
- input signal ranges

- C200H-AD003, 11
 - DM set value, 21
 - setting, 21
- C200H-MAD01, 67
 - DM set value, 80
 - setting, 81
- inputs
 - C200H-AD003
 - IR adjustment mode set value, 19
 - setting, 21
 - C200H-DA003, IR adjustment mode set value, 48
 - C200H-DA004, IR adjustment mode set value, 48
 - C200H-MAD01
 - IR adjustment mode set value, 78
 - setting, 81
- IR area, unit number setting, 7
 - C200H-AD003, 13
 - C200H-DA003, 41
 - C200H-DA004, 41
 - C200H-MAD01, 71
- IR area allocation
 - C200H-AD003, 17
 - adjustment mode, 19
 - normal mode, 18
 - set and stored values for adjustment mode, 19
 - set and stored values for normal mode, 18
 - C200H-DA003, 46
 - adjustment mode, 48
 - normal mode, 47
 - set and stored values for adjustment mode, 48
 - set and stored values for normal mode, 47
 - C200H-DA004, 46
 - adjustment mode, 48
 - normal mode, 47
 - set and stored values for adjustment mode, 48
 - set and stored values for normal mode, 47
 - C200H-MAD01, 76
 - adjustment mode, 78
 - normal mode, 77
 - set and stored values for adjustment mode, 78
 - set and stored values for normal mode, 77

L–M

- line breakage
 - C200H-AD003, 15
 - C200H-MAD01, 73
- mean value function, 3
 - C200H-AD003, 23
 - DM set value, 21
 - C200H-MAD01, 82
 - DM set value, 80
- mean value processing, conversion program, 122
- mounting, 6

N

- noise resistance
 - C200H-AD003, 17
 - C200H-DA003, 45
 - C200H-DA004, 45
 - C200H-MAD01, 75

nomenclature

- C200H-AD003, 12
- C200H-DA003, 40
- C200H-DA004, 40
- C200H-MAD01, 70

normal mode

- C200H-AD003, IR area allocation, 18
- C200H-DA003, IR area allocation, 47
- C200H-DA004, IR area allocation, 47
- C200H-MAD01, IR area allocation, 77

O

offset adjustment function, 3

bits used

- C200H-AD003, 28
- C200H-DA003, 55
- C200H-DA004, 55
- C200H-MAD01 for input, 93
- C200H-MAD01 for output, 99

clearing

- C200H-AD003, 32
- C200H-DA003, 61
- C200H-DA004, 61
- C200H-MAD01 for input, 97
- C200H-MAD01 for output, 104

input number specification

- C200H-AD003, 28
- C200H-MAD01, 93

output number specification

- C200H-DA003, 55
- C200H-DA004, 55
- C200H-MAD01, 98

procedure, 8

- C200H-AD003, 28
- C200H-DA003, 55
- C200H-DA004, 55
- C200H-MAD01 for input, 94
- C200H-MAD01 for output, 99

Offset Bit

- C200H-AD003, IR set value, 19
- C200H-DA003, IR set value, 48
- C200H-DA004, IR set value, 48
- C200H-MAD01, IR set value, 78

operation mode switch

- C200H-AD003, 14
- C200H-DA003, 42
- C200H-DA004, 42
- C200H-MAD01, 71

output hold function, 3

- C200H-DA003, 51
- C200H-DA004, 51
- C200H-MAD01, 87

output setting error

- C200H-DA003, 53
 - IR normal mode stored value, 47
- C200H-DA004, 53
 - IR normal mode stored value, 47
- C200H-MAD01, 89
 - IR normal mode stored value, 77

output signal ranges

- C200H-DA003, 39
 - DM set value, 50
 - setting, 50
- C200H-DA004, 39
 - DM set value, 50
 - setting, 50
- C200H-MAD01, 68
 - DM set value, 80
 - setting, 86

output status when stopped

- C200H-DA003, DM set value, 50
- C200H-DA004, DM set value, 50
- C200H-MAD01, DM set value, 80

outputs

- C200H-DA003, setting, 50
- C200H-DA004, setting, 50
- C200H-MAD01
 - IR adjustment mode set value, 78
 - setting, 86

P

peak value function, 3

- C200H-AD003, 25
 - IR normal mode set value, 18
- C200H-MAD01, 84
 - IR normal mode set value, 77

precautions, 6

- general, xi

programs, sample, 115

R

ratio conversion function, 3, 89

ratio set value, 91

Restart Bits

- C200H-AD003, 34
- C200H-DA003, 63
- C200H-DA004, 63
- C200H-MAD01, 108

S

sample programs, 115

scaling, conversion program, 118

Set Bit

- C200H-AD003, IR set value, 19
- C200H-DA003, IR set value, 48
- C200H-DA004, IR set value, 48
- C200H-MAD01, IR set value, 78

set values

- C200H-DA003, IR normal mode, 47
- C200H-DA004, IR normal mode, 47
- C200H-MAD01, IR normal mode, 77

writing

- C200H-DA003, 52
- C200H-DA004, 52
- C200H-MAD01, 87

settings, procedure, 8

signal names

- C200H-AD003, 14
- C200H-DA003, 42
- C200H-DA004, 43
- C200H-MAD01, 72

Slave Racks, 5

Special I/O Unit Error Flags

- C200H-AD003, 34
- C200H-DA003, 63
- C200H-DA004, 63
- C200H-MAD01, 107

specifications

- C200H-AD003, 10
- C200H-DA003, 38
- C200H-DA004, 38
- C200H-MAD01, 66

square root, conversion program, 121

system configuration, 4, 5

T

terminal block

- C200H-AD003, 13
 - mounting screw torque, 13
- C200H-DA003, 41
 - mounting screw torque, 41
- C200H-DA004, 41
 - mounting screw torque, 41
- C200H-MAD01, 70
 - mounting screw torque, 70

terminals

- C200H-AD003, 14
 - C200H-DA003, 42
 - C200H-DA004, 43
 - C200H-MAD01, 72
- short-circuiting
- C200H-AD003, 16
 - C200H-MAD01, 74

troubleshooting

- C200H-AD003, 33, 35
- C200H-DA003, 62, 64
- C200H-DA004, 62, 64
- C200H-MAD01, 105, 108

U–W

unit number switch, 7

- C200H-AD003, 13
- C200H-DA003, 41
- C200H-DA004, 41
- C200H-MAD01, 71

Units, number, 5

Up Bit

- C200H-DA003, IR set value, 48
- C200H-DA004, IR set value, 48
- C200H-MAD01, IR set value, 78

use designation

- C200H-AD003, DM set value, 21
- C200H-DA003, DM set value, 50
- C200H-DA004, DM set value, 50
- C200H-MAD01
 - DM set value for input, 80
 - DM set value for loop, 80
 - DM set value for output, 80

wiring

- C200H-AD003, 14
 - example, 16
 - line breakage, 15
 - precautions, 17
- C200H-DA003, 42
 - example, 44
 - precautions, 45
- C200H-DA004, 42
 - example, 44
 - precautions, 45
- C200H-MAD01, 72
 - example, 74
 - line breakage, 73
 - precautions, 75

Revision History

A manual revision code appears as a suffix to the catalog number on the front cover of the manual.

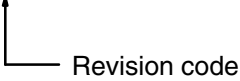
Cat. No. W325-E1-04

The following table outlines the changes made to the manual during each revision. Page numbers refer to the previous version.

Revision code	Date	Revised content
1	August 1997	Original production
2	June 1998	<p>Pages xii to xiv: Precautionary information changed.</p> <p>Pages 10, 67: “Approximately” added to the conversion time of 0.3 ms in note 4.</p> <p>Page 20: CPU Unit model numbers corrected.</p> <p>Pages 27, 54, 92: I/O table information added to the Caution.</p> <p>Page 38: “Approximately” added to the conversion time of 0.3 ms in note 3.</p> <p>Page 67: Conversion time addition corrected from “0.9 ms” to “0.3 ms.”</p> <p>Page 105: Error code F0 added to the table.</p> <p>Pages 116, 117: <i>Sample Program 5: Scaling</i> rewritten and added to.</p>
3	May 1999	<p>Pages xii to xiv: Precautionary information changed.</p> <p>Pages 15, 73: “Line Breakage while Using Voltage Input” section added.</p> <p>Pages 27, 30, 31, 54, 58, 60, 92, 94, 96, 97, 100, 103: Offset adjustment and gain adjustment information added to the Caution.</p> <p>Page 41: “Analog Input Unit” corrected to “Analog Output Unit” in the first sentence of <i>3-2-2 Unit Number Switch</i>.</p> <p>Page 47: Left column of the IR allocation table corrected.</p> <p>Page 89: Loop 1 and 2 bit settings for <i>Specifying I/O Relationships</i> corrected.</p> <p>Pages 113, 116, 117, 120: Minor corrections to the sample program information.</p> <p>Page 127: Loop 1 and 2 bit settings for <i>Use Designation</i> corrected.</p>
4	June 2003	<p>Page xii: Safety precautions added.</p> <p>Page xiii: “Power Supply Units” added in one place.</p> <p>Page 4: Information on mounting limitations added.</p> <p>Page 38: Note added after table.</p> <p>Page 66: Two lines added to table.</p> <p>Page 67: Note added after table.</p>



OMRON ELECTRONICS LLC

1 Commerce Drive
Schaumburg, IL 60173
847.843.7900
For US technical support or
other inquiries: 800.556.6766

OMRON CANADA, INC.

885 Milner Avenue
Toronto, Ontario M1B 5V8
416.286.6465

OMRON ON-LINE

Global - <http://www.omron.com>
USA - <http://www.omron.com/oei>
Canada - <http://www.omron.ca>

UNITED STATES

To locate a Regional Sales Office, local Distributor or
to obtain product information, call: 847.843.7900

CANADA REGIONAL SALES OFFICES

Ontario	Toronto	416.286.6465
	Kitchener	519.896.1144
	Kingston	613.376.3968
Quebec	Montreal	514.636.6676
British Columbia	Vancouver	604.522.8855
Alberta	Edmonton	403.440.0818
	Calgary	403.257.3095

BRAZIL SALES OFFICE

Sao Paulo 55.11.5564.6488

ARGENTINA SALES OFFICE

Cono Sur 54.114.787.1129

MEXICO SALES OFFICES

Florida 954.227.2121 **Ciudad Juarez** 656.623.7083
Mexico, D.F. 555.534.1195 **Monterrey, N.L.** 818.377.4281